

FVA-Workbench

Module Descriptions

Version 7.1
Q1 2022

FVA GmbH
Lyoner Straße 18
60528 Frankfurt / Main
T +49 69 6603 1663
www.fva-service.de
info@fva-service.de

[↳ Direct to overview of modules \(p. 2\)](#)

Table of Contents

What is the FVA-Workbench?	1
Editions	1
License Types	1
Overview of Modules	2
Types of Calculations in the FVA-Workbench	4
System-Level Calculations	4
Individual Component Calculations	5
Reporting of Calculation Results	6
User Guidance and Help	8
3D Visualization	9
Scripting [WB_200.1]	10
Excel & DXF Scripting Interface [WB_200.5]	12
DXF File Export	12
Excel Data Import and Export	13
Advanced Automation [WB_200.4]	14
Batch Operation	14
Automation of Calculations [WB_200.2]	15
REXS Exchange Interface	16
GDE Data Import [ST_200.7]	17
Lifetime Estimation	18
Power Flow [SYS_100.1]	19
Efficiency and Temperature - FVA 69 [SYS_200.1]	20
Cylindrical Gear Geometry and Load Capacity - FVA 241 [ST_100.1]	22
Cylindrical Gear Geometry Design	22
Cylindrical Gear Load Carrying Capacity	24
Gear Mesh Excitation - FVA 338 [ST_200.4]	26
Cylindrical Gear Classification Societies - FVA 241 [ST_200.1]	28
Cylindrical Gear 2D Flank Load Distribution - FVA 30 [SYS_100.3]	29
Cylindrical Gear 3D Flank Load Distribution - FVA 30 [ST_200.2]	30
Cylindrical Gear 3D Flank Load Distribution - FVA 127 [ST_200.3]	32
Cylindrical Gear Local Tooth Root Stress - FVA 732 [ST_200.6]	34
Plastic Gear Load Capacity - VDI 2736 [ST_100.3]	35
FE Plastic Gears [ST_200.8]	36
Bevel Gear Load Capacity [KS_200.1]	37
Bevel Gear Classification Societies - FVA 49 [KS_200.2]	38
Bevel Gear Local Load Capacity - FVA 223 [KS_200.3]	39
Worm Gear Load Capacity - FVA 320 [SN_200.1]	42
Worm Gear Local Load Capacity - FVA 320 [SN_200.2]	43
Crossed Helical Gear Load Capacity - FVA 651 [SCH_200.1]	45
Rolling Bearing Calculations - FVA 668 & FVA 364 [WL_200.1]	46
Thrust Bearing Simulations - FVA 668 [GL_200.2]	47
Journal Bearing Simulations - FVA 577 [GL_200.1]	48
Shaft Load Capacity - DIN 743 & FVA 700 [WL_100.1]	49
Shaft Load Capacity - FKM [WL_100.5]	50
Press Fit Load Capacity - FVA 424 [WL_100.3]	51
Feather Key Load Capacity - FVA 217 [WL_100.2]	52

Spline Gear Geometry and Load Capacity [ST_100.4]	53
Multiple Interference Fit Load Capacity - FVA 424 [WL_100.4]	54
Load Spectrum Calculations [SYS_100.4]	55
Eigenvalue Analysis - FVA 565 [SYS_200.5]	57
Lubrication Network Calculations - FVA 804 [LUB 200.1]	58
Coupling FEM Structures with the Analytical Calculation Model	59
Modules for Importing CAD Files and FE Meshes	60
Casing FEM Connections - FVA 711 [SSFEM_200.2]	61
Planet Carrier FEM Connections - FVA 774 [SSFEM_200.3]	62
Shaft FEM Connections [SSFEM_200.4]	63
FEM Mesher (Including STEP Import) [FEM_200.1]	64
FEM Component Deformation [FEM_300.1]	65
CAD Export	66
Exportable CAD Formats	66
Appendix	67
List of Sources	67

What is the FVA-Workbench?

The FVA-Workbench is the leading software for calculation and simulation of individual drive elements and complex transmission systems. It bundles 50 years of knowledge from the world's largest drive technology research and innovation network, Forschungsvereinigung Antriebstechnik e.V. (FVA, the Research Association for Drive Technology). New findings are continuously defined, developed, and validated in joint industrial research projects and then systematically integrated into the FVA-Workbench. Thus, the software always reflects the current state of research in addition to classic standard calculation methods.

Modular design for customized solutions

The modular design of the FVA-Workbench means that the number and combination of modules can be customized to fit your individual your needs. This ensures tailor-made solutions for a wide range of applications. Numerous CAD and FE interfaces are also available.

Licensing periods: added flexibility

Would you like to try the FVA-Workbench for a single project first? No problem. You can also choose your own licensing terms. Regardless of whether you choose 3 months, 6 months, or an entire year - usage, maintenance, support, and software updates for all licensed modules are included during the license period.

Editions

The Modeler, Extended, and Advanced Edition packages differ in the scope of their standard configuration (modules included in the standard package), as well as the number of available optional modules for specialized applications. Additional optional modules can be added at any time.



Modeler Edition

FVA-Workbench Modeler Edition is perfect for users who develop new gearbox concepts, analyze existing gearbox models, or customize them for additional simulations.



Extended Edition

FVA-Workbench Extended Edition is the perfect standard calculation tool for the entire drive system product development process.



Advanced Edition

FVA-Workbench Advanced Edition includes additional FVA calculation methods for product development based on current findings from research and technology.

License Types



Single-user license (client license)

A client license is bound to a specific computer and allows a single user to access the FVA-Workbench.



Network license (floating license)

With a network license, any number of users on the same network can share product licenses.

Overview of Modules

Legend

Included	✓
Optional	○

Module		FVA-Workbench Edition		
		Modeler	Extended	Advanced
Basic Features				
Power Flow [SYS_100.1]	(p. 19)	✓	✓	✓
Cylindrical Gear Geometry and Load Capacity - FVA 241 [ST_100.1]	(p. 22)	✓	✓	✓
Plastic Gear Load Capacity - VDI 2736 [ST_100.3]	(p. 36)	✓	✓	✓
Spline Gear Geometry and Load Capacity [ST_100.4]	(p. 53)	✓	✓	✓
3D Visualization	(p. 9)	✓	✓	✓
Reporting of Calculation Results	(p. 6)	✓	✓	✓
User Guidance and Help	(p. 8)	✓	✓	✓
Lifetime Estimation	(p. 18)	✓	✓	✓
System Deformation Analysis - FVA 30	(p. 4)		✓	✓
Cylindrical Gear 2D Flank Load Distribution - FVA 30 [SYS_100.3]	(p. 29)		✓	✓
Shaft Load Capacity - DIN 743 & FVA 700 [WL_100.1]	(p. 49)		✓	✓
Feather Key Load Capacity - FVA 217 [WL_100.2]	(p. 52)		✓	✓
Press Fit Load Capacity - FVA 424 [WL_100.3]	(p. 51)		✓	✓
Multiple Interference Fit Load Capacity - FVA 424 [WL_100.4]	(p. 54)		✓	✓
Shaft Load Capacity - FKM [WL_100.5]	(p. 50)		✓	✓
Rolling Bearing Calculations - FVA 668 & FVA 364 [WL_200.1]	(p. 46)	○	✓	✓
Cylindrical Gear 3D Flank Load Distribution - FVA 30 [ST_200.2]	(p. 30)			✓
Cylindrical Gear 3D Flank Load Distribution - FVA 127 [ST_200.3]	(p. 32)			✓
Efficiency and Temperature - FVA 69 [SYS_200.1]	(p. 20)			✓
Load Spectrum Calculations [SYS_100.4]	(p. 55)		○	○
Cylindrical Gear Classification Societies - FVA 241 [ST_200.1]	(p. 28)	○	○	○
GDE Data Import [ST_200.7]	(p. 17)	○	○	○
Cylindrical Gear Local Tooth Root Stress - FVA 732 [ST_200.6]	(p. 34)			○
Lubrication Network Calculations - FVA 804 [LUB 200.1]	(p. 58)	○	○	○
FE Plastic Gears [ST_200.8]	(p. 35)			○
Automation				
Scripting [WB_200.1]	(p. 10)	○	○	○
Automation of Calculations [WB_200.2]	(p. 15)	○	○	○
Excel & DXF Scripting Interface [WB_200.5]	(p. 12)	○	○	○
Advanced Automation [WB_200.4]	(p. 14)	○	○	○
NVH (Noise Vibration Harshness)				
Eigenvalue Analysis - FVA 565 [SYS_200.5]	(p. 57)		○	○
Gear Mesh Excitation - FVA 338 [ST_200.4]	(p. 26)			○

Module		FVA-Workbench Edition		
		Modeler	Extended	Advanced
Finite Elements				
Casing FEM Connections - FVA 711 [SSFEM_200.2]	(p. 61)	<input type="radio"/>	<input type="radio"/>	<input type="radio"/>
Planet Carrier FEM Connections - FVA 774 [SSFEM_200.3]	(p. 62)	<input type="radio"/>	<input type="radio"/>	<input type="radio"/>
Shaft FEM Connections [SSFEM_200.4]	(p. 63)		<input type="radio"/>	<input type="radio"/>
FEM Mesher (Including STEP Import) [FEM_200.1]	(p. 64)	<input type="radio"/>	<input type="radio"/>	<input type="radio"/>
FEM Component Deformation [FEM_300.1]	(p. 65)		<input type="radio"/>	<input type="radio"/>
Bevel Gears				
Bevel Gear Load Capacity [KS_200.1]	(p. 37)	<input type="radio"/>	<input type="radio"/>	<input type="radio"/>
Bevel Gear Classification Societies - FVA 49 [KS_200.2]	(p. 38)	<input type="radio"/>	<input type="radio"/>	<input type="radio"/>
Bevel Gear Local Load Capacity - FVA 223 [KS_200.3]	(p. 39)	<input type="radio"/>	<input type="radio"/>	<input type="radio"/>
Plain Bearings				
Journal Bearing Simulations - FVA 577 [GL_200.1]	(p. 48)	<input type="radio"/>	<input type="radio"/>	<input type="radio"/>
Thrust Bearing Simulations - FVA 668 [GL_200.2]	(p. 47)	<input type="radio"/>	<input type="radio"/>	<input type="radio"/>
Special Gears				
Worm Gear Load Capacity - FVA 320 [SN_200.1]	(p. 42)	<input type="radio"/>	<input type="radio"/>	<input type="radio"/>
Worm Gear Local Load Capacity - FVA 320 [SN_200.2]	(p. 43)			<input type="radio"/>
Crossed Helical Gear Load Capacity - FVA 651 [SCH_200.1]	(p. 45)	<input type="radio"/>	<input type="radio"/>	<input type="radio"/>
CAD Export				
CATIA V4 Export [SSCADW_200.1]	(p. 66)	<input type="radio"/>	<input type="radio"/>	<input type="radio"/>
CATIA V5 Export [SSCADW_200.2]		<input type="radio"/>	<input type="radio"/>	<input type="radio"/>
IGES Export [SSCADW_200.3]		<input type="radio"/>	<input type="radio"/>	<input type="radio"/>
STEP Export [SSCADW_200.4]		<input type="radio"/>	<input type="radio"/>	<input type="radio"/>
VDA-FS Export [SSCADW_200.5]		<input type="radio"/>	<input type="radio"/>	<input type="radio"/>
ACIS SAT Export [SSCADW_200.6]		<input type="radio"/>	<input type="radio"/>	<input type="radio"/>
CAD Import				
CATIA V5 Model Import (*.CATPart) [SSCADR_200.1]	(p. 60)	<input type="radio"/>	<input type="radio"/>	<input type="radio"/>
Pro/E Model Import (*.prt) [SSCADR_200.2]		<input type="radio"/>	<input type="radio"/>	<input type="radio"/>
Solid Edge Model Import (*.par) [SSCADR_200.3]		<input type="radio"/>	<input type="radio"/>	<input type="radio"/>
SolidWorks Model Import (*.sldprt) [SSCADR_200.4]		<input type="radio"/>	<input type="radio"/>	<input type="radio"/>
Inventor Model Import (*.ipt) [SSCADR_200.5]		<input type="radio"/>	<input type="radio"/>	<input type="radio"/>
SIEMENS NX Model Import (*.prt) [SSCADR_200.6]		<input type="radio"/>	<input type="radio"/>	<input type="radio"/>
Import of FE Meshes				
Abaqus (*.inp) & Ansys (*.dat) FE Mesh Import [SSFEMR_200.1]	(p. 60)	<input type="radio"/>	<input type="radio"/>	<input type="radio"/>

Types of Calculations in the FVA-Workbench

System-Level Calculations

Modeler	Extended	Advanced
	✓	✓

All cross influences between the machine elements of a complete gear system in an operating state must be considered for correct transmission system design. These cross influences are dependent on the elasticity of the machine elements and lead to a complex deformation state.

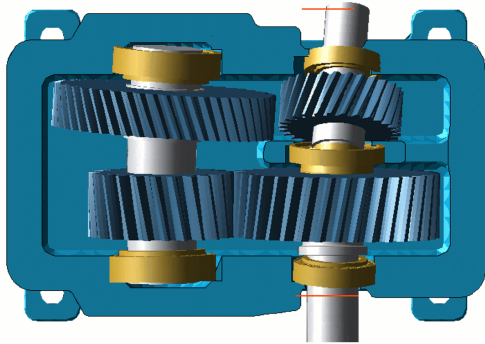

Representation of the total system deformation in an FVA-Workbench 3D model

The power flow and the deformations for the entire gearbox are calculated in the system calculation. All forces and displacements within the system are automatically transferred to the individual machine elements. Thus, all deformation cross influences are considered in subsequent load capacity calculations. The stiffness and deformation behavior are calculated for all machine elements:

- Shafts, plain and rolling bearings, shaft-hub connections, couplings
- Cylindrical, bevel, spiral, and worm gear stages
- Gearbox casing, planet carriers

The system must be solved iteratively due to non-linear behavior; for example, of the bearing locations within the gearbox. Important information can be gained about the gearbox and additional calculations can be performed based on the loads and deformations.

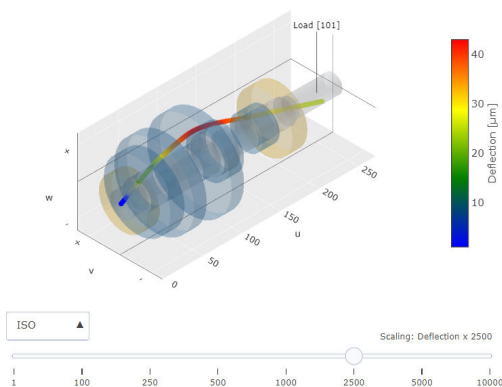

Shaft deformation

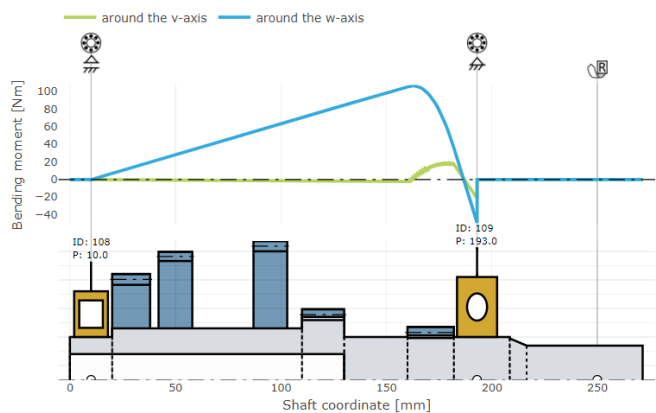

Bending moment profile

The calculation of the load and deformation state of the transmission system form the basis for further in-depth analyses. These are integrated into the system calculation as a post-processing step.

Influencing factors

In addition to the load distribution across the face width of a gear, several other influencing factors can be determined. With power splitting, for example as used in planetary gears, the load distribution is not always uniform. The power, and therefore the load on the machine elements, is distributed according to the actual stiffness. In planetary gears, the influence of gravity or uneven distribution of the planets can be the cause of uneven load distribution. Additionally, (measured) planet-specific displacements can be specified.

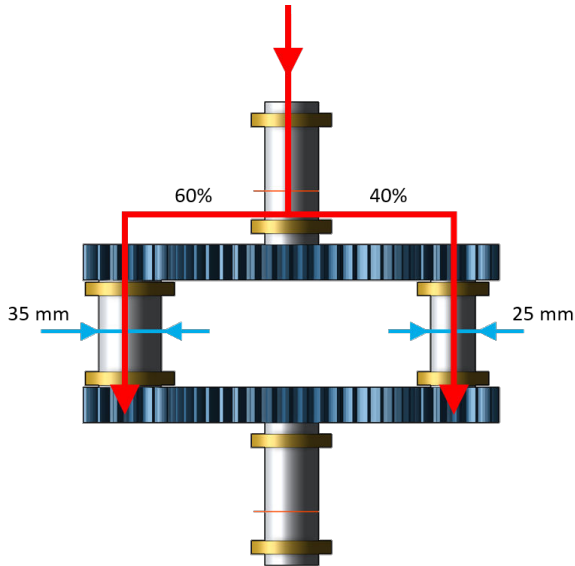

The influence of different shaft diameters on power splitting.

Bevel gears are more vulnerable to axial offset than cylindrical gears. For this reason, knowledge of the displacement of the bevel tip is essential for the calculation and correct design. In conjunction with the "Bevel Gear Local Load Capacity - FVA 223 [KS_200.3]" module, the effects of the deformation on the contact pattern and safety factors can be easily evaluated.

Individual Component Calculations

For individual component calculations, a single machine element is calculated without its environment. The forces and displacements are specified by the user. Cross influences from the gearbox environment are not considered.

Individual component calculations are performed separately for each component.

Reporting of Calculation Results

Modeler	Extended	Advanced
✓	✓	✓

The reporting feature in the FVA-Workbench greatly simplifies and accelerates the documentation of calculation results. Results are displayed as tables and interactive diagrams and stored in a central location. Key features include:

- Easy-to-interpret results
- More than 150 interactive 2D and 3D charts
- Layout can be freely configured using drag & drop
- Export of fully functional reports in HTML format
- Simple copy & paste of data

Example report

The screenshot shows a report for 'Cylindrical stage [24]'. The header includes 'Project name: 2-Stage Gearbox', 'Customer: FVA GmbH', and 'Created: 13.08.19 16:45'. The main content is divided into several sections:

- 1. Hierarchical tree:** A search model tree on the left showing the assembly structure: Gear unit [1], Casing [2], Cylindrical stage [24], Cylindrical stage [41], Shaft [25], Cylindrical gear [44], Rolling bearing [45], Load [54], Notch [78], Notch [81], Rolling bearing [86], and Rolling bearing [90].
- 2. Customizable header:** The top section of the report with the FVA logo and 'Example Report' title.
- 3. 3D representation:** A 3D model of the cylindrical gear assembly.
- 4. Interactive contour diagram:** A 'Load distribution (contour plot)' showing pressure distribution on the gear teeth. A tooltip indicates coordinates: x: 23.4375, y: 9.684464, z: 201.7969.
- 5. Results table:** A table for 'DIN 3960 - Main geometry' with columns for 'Sym.', 'Cylindrical gear [27]', 'Cylindrical gear [28]', and 'Unit'.

Sym.	Cylindrical gear [27]	Cylindrical gear [28]	Unit
Normal pressure angle	α_n	20.00000	°
Helix angle at reference diameter	β	21.00000	°
Number of teeth	z	27	51
Center distance	a	190.000	mm
Normal module	m_n	4.50000	mm
Transverse module	m_t	4.82015	mm
Addendum modification coeff.	x	0.3000	0.1628
Face width	b	50.000	mm
Common face width	b_{com}	50.00	mm
Gap width	b_{sp}	0.000	mm
Tip diameter	d_a	141.84	256
Transverse contact ratio	ϵ_a	1.464	
Overlap contact ratio	ϵ_p	1.247	
Total contact ratio	ϵ_{Σ}	2.732	
- 6. Interactive line diagram:** A '3D transmission error' plot showing 'Transmission error (under load)' and 'Support points' over a 'Rolling path [mm]'. A fluctuation range of 1.91 μm is indicated.

1. Complete Model Tree for navigation within the report
2. Customizable header
3. 3D representation of the machine element
4. Interactive contour diagram with "hover over" function
5. Freely configurable results table with "copy to clipboard" function
6. Interactive line diagram with "zoom" function

All entries and calculation results are stored as attributes. Users have full access to these attributes and can use them to create custom reports.



Example report - system analysis of a wind turbine gearbox

Example report - helix angle modification vs. no flank modifications

Available at www.fva-service.de

Create custom reports

A report consists of multiple sections, each of which describes a machine element. These sections can be populated with tables, charts, and 3D graphics in the Report Configurator. The position, layout, and order can be freely configured using drag & drop. Report templates created in this way can then be used for any gearbox design.

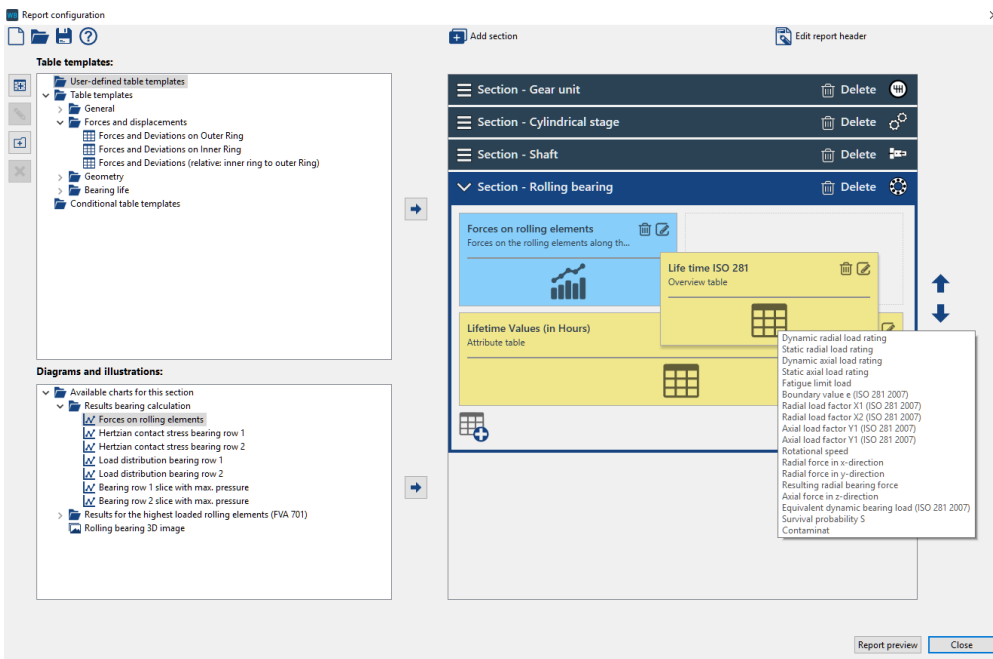

Report charts, tables, and graphics can be compiled in the Report Configurator.

Compare results

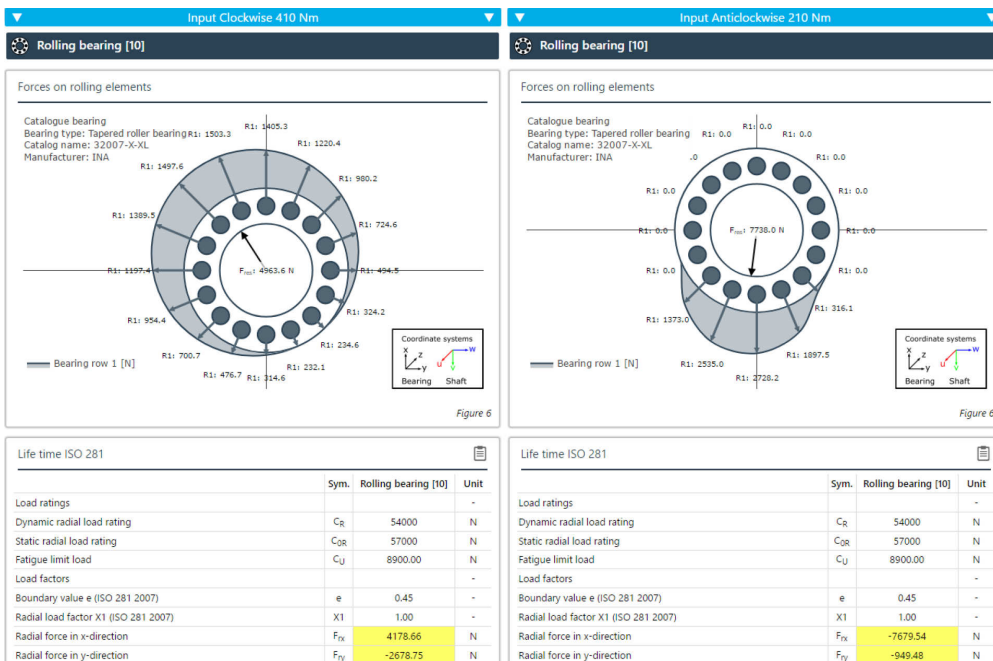

The comparison feature can be used to display two reports side-by-side, highlighting any differences.

User Guidance and Help

Modeler	Extended	Advanced
✓	✓	✓

The interface supports users with input logic as well as consistency and completeness checks to make working in the FVA-Workbench fast and efficient. Context-sensitive help provides additional information about input fields.

Intuitive user guidance in the FVA-Workbench

The screenshot displays the FVA-Workbench 6.0 interface with three numbered callouts highlighting key features:

- 1. Messages window:** Located at the bottom center, it shows a list of messages including errors (e.g., "Mesh stiffness according to ISO 6336 (2006) Cylindrical stage [4]", "Cylindrical gear [6]: Chamfer at tooth end must be specified.") and warnings (e.g., "Analysis of gear meshing Cylindrical stage [4]", "Cylindrical stage [4]: The tip of gear Cylindrical gear [6] is causing a meshing interference in the root of gear Cylindrical gear [8].").
- 2. Context-sensitive help:** Located on the right side, it shows a help window for the "Face width" parameter. It includes a table with fields: Symbol (b), Unit (mm), Attribute-ID (face width), Numeric ID (808), and Value Type (PMTechValue). Below the table are technical diagrams of gear profiles with dimensions b_1 , b_2 , $b_{1,1}$, $b_{1,2}$, $b_{2,1}$, and $b_{2,2}$.
- 3. Search attributes window:** Located at the top center, it shows a search bar and a list of attributes for the "Cylindrical stage [4]" component, including parameters like Normal pressure angle, Normal module, Number of teeth, Helix angle, Face width, Chamfer at tooth end, and Position.

1. Information in the Messages window can be used to quickly and easily identify calculation problems.
2. Context-sensitive help provides additional useful information on many FVA-Workbench input parameters.
3. The attribute search can be used to quickly find input parameters.

3D Visualization

Modeler	Extended	Advanced
✓	✓	✓

The FVA-Workbench features a powerful 3D rendering engine. All gear parameters entered by the user are represented in real-time in the 3D View. Visual input controls make gearbox modeling fully interactive. Calculation results, such as shaft deformations or bearing loads, can also be displayed directly in the 3D model.

Cutting planes can be laid through individual components or the entire gearbox to provide a better overview of the internal gear structure. If all data for a power flow calculation is available, the gearbox kinematics can also be animated. With this feature, specified parameters can be quickly validated, especially for multi-gear manual gearboxes.

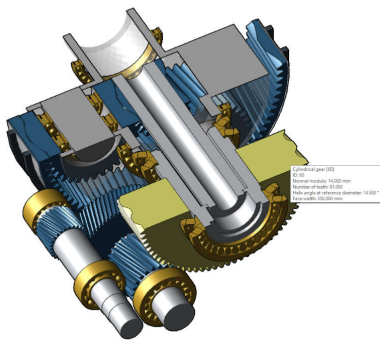

Cutting planes provide better visibility of the gearbox structure.

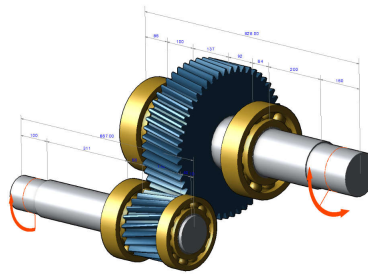

The automatic dimensioning feature simplifies the positioning of gearbox elements.

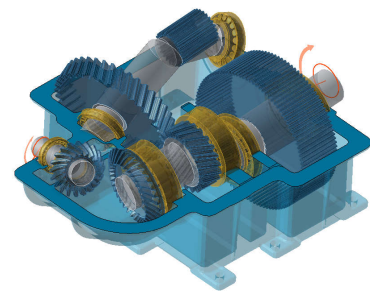

Visualization of excessive gearbox deformation makes it easy to interpret results.

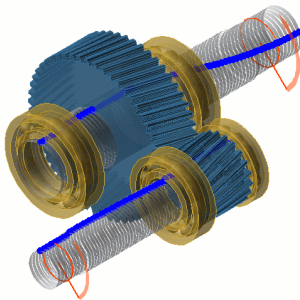

Animation of vibrations makes it possible to verify the accuracy of the critical operating points from the "Eigenvalue Analysis - FVA 565 [SYS_200.5]" module.

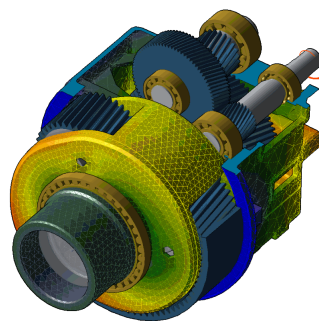

The results from the system calculation combined with the "FEM Component Deformation [FEM_300.1]" module make it possible to visualize the deformation of FEM components, such as casings and planet carriers.

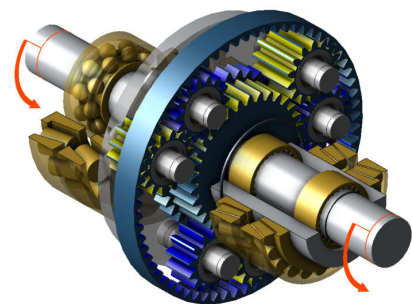

Currently loaded tooth flanks can be highlighted at the click of a button.

Scripting [WB_200.1]

Modeler	Extended	Advanced
○	○	○

The FVA-Workbench allows control and manipulation of all calculations as well as input and output attributes. Files can be output in any format for further processing.

A simple, JavaScript-based language allows users to control the system to a large degree using text instructions. Control structures such as "if/else," "for," "while," or "case" can be used.

Typical applications include:

- Optimizations
- Variational calculations
- Import and export of files from or to any external system

The execution of complex tasks can be reduced to a single mouse click.

Example script - optimization of the load distribution across the face width of cylindrical gears

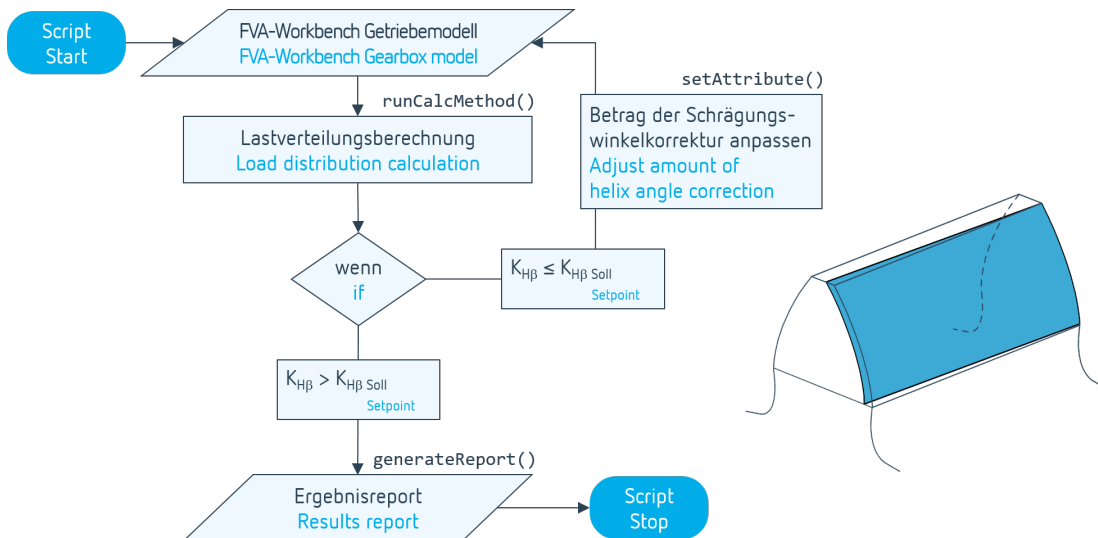

This script runs a load distribution calculation and adjusts the helix angle modification until the desired face load factor is achieved.

Example script - variation of the helix angle of a cylindrical gear stage

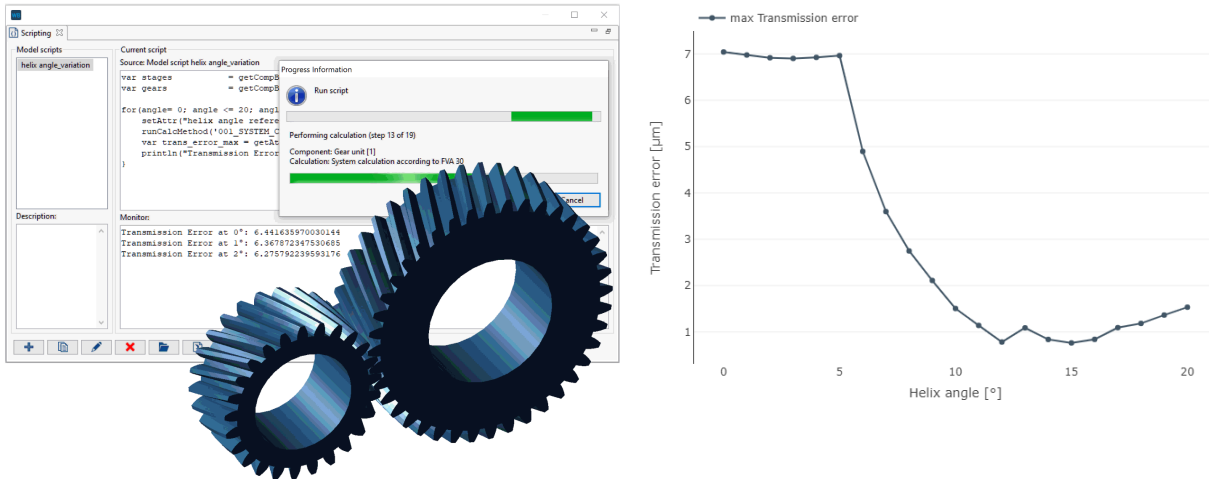

This script increases the helix angle in 1° increments, performs a system calculation including gear mesh excitation, and outputs the maximum transmission error in the Editor.

The results of the calculation can be displayed in freely configurable charts in the calculation report.

```

(1)var stages = getCompByType('cylindrical_mesh');
(2)var gears  = getCompByType('cylindrical_gear');
(3)for(angle= 0; angle <= 20; angle++){
  (4)setAttr("helix angle reference diameter", gears[0], angle, EDAT);
  (5)runCalcMethod('001_SYSTEM_CALCULATION', '1');
  (6)var trans_error_max = getAttr("result_transmission_error_maximum", stages[0], RDAT);
  (7)println("Transmission Error at "+angle+"°: "+trans_error_max );
}

```

- (1) Variable that includes a list of all cylindrical stages in the model.
- (2) Variable that includes a list of all cylindrical gears in the model.
- (3) Loop in which the run variable *angle* is increased by 1 with each pass. The execution is terminated when *angle* = 20.
- (4) Function that sets the geometry attribute "helix angle reference diameter" for the first cylindrical gear in the *gears* list to the value *angle*.
- (5) Function that starts the system calculation.
- (6) Variable that includes the calculated value (RDAT) of the attribute "result_transmission_error_maximum."
- (7) Function that displays the value of the variable *trans_error_max* on the monitor.

Excel & DXF Scripting Interface [WB_200.5]

Modeler	Extended	Advanced
<input type="radio"/>	<input type="radio"/>	<input type="radio"/>

DXF File Export

The Drawing Interchange File Format (DXF) is a file format for exchanging 2D CAD data. This module extends the scripting functionality of the FVA-Workbench with the ability to automatically create DXF shapes. Colors, text format, and line thicknesses can also be customized.

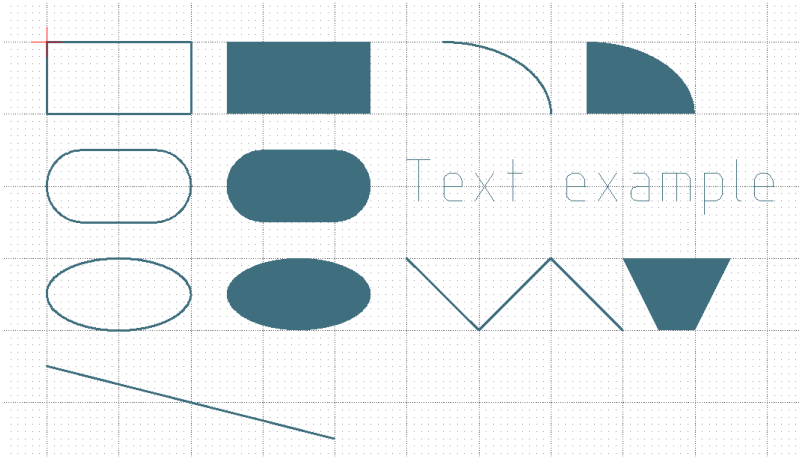

DXF shapes that can be created by script.

Example: output the calculated gear contour as a DXF file

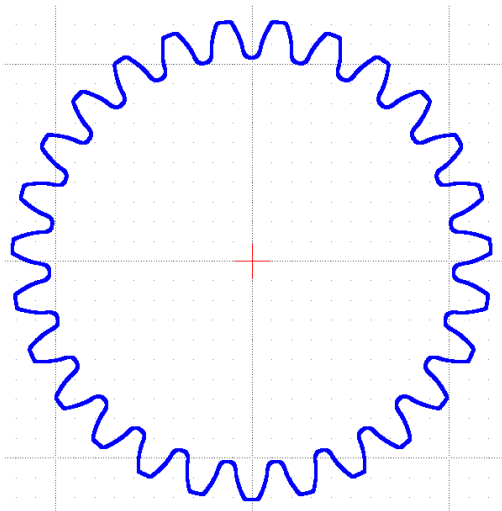

One result of the FVA-Workbench geometry calculation is the tooth contour. The coordinates are stored separately for x and y in array attributes. These attributes can be read by script and exported as a DXF line.

Excel Data Import and Export

This module extends the scripting functionality of the FVA-Workbench with the ability to read Excel files and write values. For example, input values for the teeth can be read directly from an Excel file in order to assign corresponding attributes in the FVA-Workbench transmission model. Afterwards, the calculation results can be written back to the Excel file.



This module can be used to read and write Excel files.

The layout and format of the Excel file and the cells can also be set via script. Alternatively, a formatted Excel file can be imported as a template. The formatting of the template is used, and only the values in the specified cells are replaced or added.

Key features at a glance

- Read and write individual values from Excel cells
- Read and write entire columns or rows
- Read and write matrices
- Create, rename, delete, copy worksheets
- Merge cells, change colors and text alignment

Example: variational calculations - overview of efficiency and power loss

efficiency map example													total power loss												
efficiency													total load-independent gear losses												
speed n [rpm]													speed n [rpm]												
1000 1222 1444 1667 1889 2111 2333 2556 2778 3000													1000 1222 1444 1667 1889 2111 2333 2556 2778 3000												
1000	96.57	96.45	96.3	96.15	95.99	95.83	95.66	95.49	95.32	95.14	95.00	94.86	3589	4549	5592	6720	7932	9224	10600	12063	13614	15258	17000	18840	
900	96.47	96.33	96.16	95.99	95.81	95.63	95.44	95.25	95.06	94.86	94.73	94.51	3323	4233	5224	6301	7462	8702	10027	11438	12937	14529	16210	17980	
800	96.35	96.18	95.99	95.79	95.58	95.36	95.17	94.95	94.73	94.51	94.32	94.07	3058	3916	4857	5881	6990	8178	9450	10808	12254	13799	15430	17150	
700	96.19	95.98	95.76	95.53	95.29	95.06	94.82	94.57	94.32	94.07	93.86	93.64	2793	3600	4468	5409	6426	7519	8697	10071	11543	13114	14780	16540	
600	95.98	95.73	95.46	95.19	94.92	94.64	94.36	94.07	93.78	93.48	93.26	93.03	2529	3282	4117	5034	6035	7114	8276	9524	10859	12287	13800	15400	
500	95.68	95.37	95.05	94.73	94.39	94.06	93.72	93.38	93.03	92.68	92.40	92.16	2263	2962	3741	4603	5547	6568	7672	8861	10137	11506	12970	14530	
400	95.24	94.85	94.45	94.04	93.62	93.21	92.79	92.36	91.93	91.49	91.27	91.03	1999	2638	3360	4163	5046	6006	7049	8176	9390	10699	12100	13600	
300	94.51	93.99	93.46	92.92	92.37	91.83	91.27	90.71	90.14	89.56	89.27	89.03	1734	2307	2967	3707	4526	5421	6396	7456	8602	9837	11160	12570	
200	93.12	92.35	91.57	90.78	89.98	89.18	88.37	87.54	86.7	85.85	85.54	85.30	1441	1958	2550	3219	3965	4785	5685	6668	7735	8891	10140	11480	
100	89.26	87.8	86.32	84.83	83.3	81.78	80.23	78.65	77.04	75.4	75.14	74.90	1125	1562	2069	2649	3303	4028	4830	5712	6678	7729	8860	10070	

total load-dependent gear losses													total load-independent gear losses												
speed n [rpm]													speed n [rpm]												
1000 1222 1444 1667 1889 2111 2333 2556 2778 3000													1000 1222 1444 1667 1889 2111 2333 2556 2778 3000												
1000	1.861	2.168	2.461	2.742	3.014	3.278	3.535	3.785	4.029	4.271	4.500	4.718	232.2	345.3	480	637.7	817.3	1011	1224	1454	1700	1963	2240	2530	
900	1.644	1.914	2.172	2.420	2.660	2.892	3.118	3.337	3.552	3.765	3.965	4.155	232.2	345.3	480	637.7	817.3	1011	1224	1454	1700	1963	2240	2530	
800	1.430	1.665	1.889	2.104	2.312	2.513	2.708	2.899	3.084	3.268	3.440	3.600	232.2	345.3	480	637.7	817.3	1011	1224	1454	1700	1963	2240	2530	
700	1.222	1.422	1.612	1.795	1.972	2.143	2.309	2.470	2.627	2.782	2.920	3.045	232.2	345.3	480	637.7	817.3	1011	1224	1454	1700	1963	2240	2530	
600	1.018	1.185	1.343	1.494	1.641	1.782	1.919	2.052	2.181	2.310	2.420	2.520	232.2	345.3	480	637.7	817.3	1011	1224	1454	1700	1963	2240	2530	
500	820.9	954.2	1091	1202	1319	1432	1541	1647	1750	1851	1940	2020	232.2	345.3	480	637.7	817.3	1011	1224	1454	1700	1963	2240	2530	
400	630.2	731.8	828.3	920.4	1009	1094	1177	1256	1334	1410	1480	1540	232.2	345.3	480	637.7	817.3	1011	1224	1454	1700	1963	2240	2530	
300	449	520.6	588.4	652.0	714.6	774	831	886	939.1	991.4	1040	1080	232.2	345.3	480	637.7	817.3	1011	1224	1454	1700	1963	2240	2530	
200	278.1	321.6	362.5	401.2	437.9	473	506.5	538.5	569	598.9	627	654	232.2	345.3	480	637.7	817.3	1011	1224	1454	1700	1963	2240	2530	
100	131.5	139.5	156.1	171.4	185.7	199	211.4	223.9	235.5	245.5	255	265	232.2	345.3	480	637.7	817.3	1011	1224	1454	1700	1963	2240	2530	

total load-dependent bearing losses													total load-independent bearing losses												
speed n [rpm]													speed n [rpm]												
1000 1222 1444 1667 1889 2111 2333 2556 2778 3000													1000 1222 1444 1667 1889 2111 2333 2556 2778 3000												
1000	1.356	1.814	2.317	2.859	3.434	4.038	4.666	5.315	5.981	6.662	7.350	8.040	105.5	180.2	284.3	422.7	600.5	822.7	1094	1421	1806	2257	2780	3370	
900	1.307	1.751	2.238	2.762	3.319	3.903	4.510	5.137	5.782	6.441	7.100	7.760	105.5	180.2	284.3	422.7	600.5	822.7	1094	1421	1806	2257	2780	3370	
800	1.255	1.683	2.153	2.659	3.195	3.757	4.342	4.946	5.567	6.201	6.840	7.480	105.5	180.2	284.3	422.7	600.5	822.7	1094	1421	1806	2257	2780	3370	
700	1.199	1.610	2.061	2.546	3.060	3.599	4.159	4.738	5.333	5.940	6.550	7.160	105.5	180.2	284.3	422.7	600.5	822.7	1094	1421	1806	2257	2780	3370	
600	1.138	1.530	1.959	2.421	2.911	3.424	3.958	4.509	5.074	5.653	6.240	6.830	105.5	180.2	284.3	422.7	600.5	822.7	1094	1421	1806	2257	2780	3370	
500	1.070	1.440	1.846	2.282	2.744	3.228	3.732	4.251	4.785	5.330	5.880	6.430	105.5	180.2	284.3	422.7	600.5	822.7	1094	1421	1806	2257	2780	3370	
400	992.6	1338	1717	2123	2553	3004	3473	3956	4453	4960	5480	6010	105.5	180.2	284.3	422.7	600.5	822.7	1094	1421	1806	2257	2780	3370	
300	902.3	1219	1564	1935	2328	2739	3166	3607	4059	4521	5000	5490	105.5	180.2	284.3	422.7	600.5	822.7	1094	1421	1806	2257	2780	3370	

In this example, the speed and torque of a transmission are varied by a script. For each combination, the efficiency and power loss of each machine element are written separately to an Excel file.

Advanced Automation [WB_200.4]

Modeler	Extended	Advanced
<input type="radio"/>	<input type="radio"/>	<input type="radio"/>

Batch Operation

The batch operation feature combines scripting functions with the option to start the FVA-Workbench automatically. This feature can be used to completely automate catalog calculations, strength analyses, and variational calculations.

This makes it possible to integrate the FVA-Workbench into internal company process and program chains. The FVA-Workbench starts without the graphical user-interface, executes predefined scripts one after the other, saves the results in a user-defined location, and automatically shuts down.

Application example

The company's online configurator calls up the FVA-Workbench and transfers gearbox parameters for the selected modular transmission via script. The script also triggers the load capacity calculation. The FVA-Workbench then outputs the desired load capacity values in a format that can be read by the online configurator. The data can now be imported by the configurator and included in the customer report.

A company manufactures modular gearboxes and wants to calculate the load carrying capacity of various component combinations. The sales department can configure gearboxes using an online tool and provide technical details and prices to customers. This information needs to be expanded to include the load carrying capacity.

The [standardized REXS interface \(p. 16\)](#) is ideal for seamlessly transferring gearbox models in batch operation.

Enhanced computing performance in batch operation

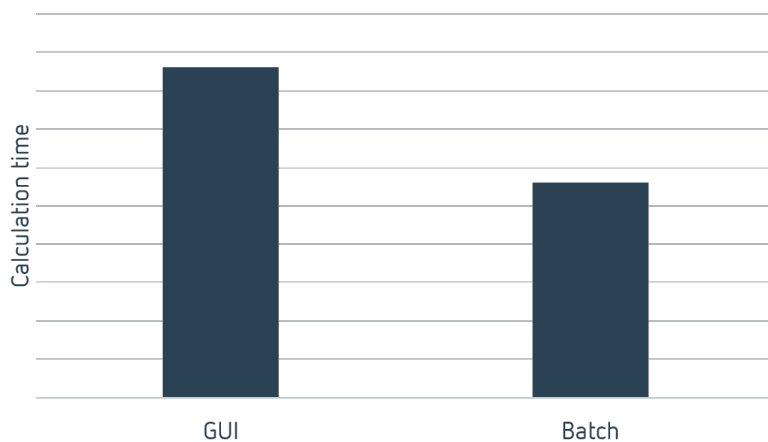

All features that are not essential for the calculation are disabled in batch operation, which increases computing performance an average of 30%. Even if only a few seconds are saved per calculation, this offers a significant advantage for mass calculations.

Automation of Calculations [WB_200.2]

Modeler	Extended	Advanced
○	○	○

Standardized boundary conditions or calculations are often agreed upon for completion of projects. To ensure that these standards are used, they can be saved in automation plans which can be applied to models. In the FVA-Workbench, automation plans are a procedural arrangement of actions that can be performed, such as setting values, executing calculations, and creating reports.

Automation is very simple and can be used without special programming knowledge. The dialog-supported interface guides the user through the creation of automation plans, making it possible to quickly and easily automate important processes. Thus, the FVA-Workbench helps to ensure quality of results and process integrity, so that all users can create consistent and reliable results.

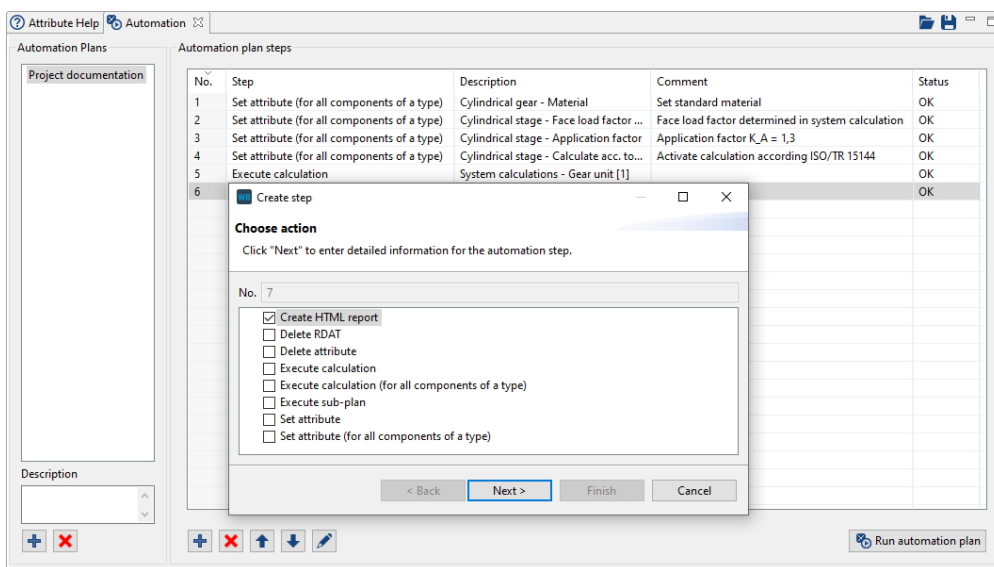

With the automation feature, various actions can be defined step-by-step and executed at the push of a button.

REXS Exchange Interface

Modeler	Extended	Advanced
✓	✓	✓

REXS (Reusable Engineering EXchange Standard) is the standardized interface for easily exchanging gear unit data. It can be used to exchange technical gearbox information between different systems.



The FVA-Workbench is reference software for the development of the interface and can always export and import gearbox models in the current REXS format. This makes it possible to transfer gearbox models between different CAE systems in order to take advantage of their respective strengths.

The aim of the REXS initiative is to provide a "digital twin" in gearbox development and calculation. REXS defines a uniform modeling and nomenclature for the gearbox and its components across standards and industries. The REXS specification is free-of-charge, manufacturer-independent, and published as an open source project under Creative Commons license.

www.rexs.info

GDE Data Import [ST_200.7]

Modeler	Extended	Advanced
<input type="radio"/>	<input type="radio"/>	<input type="radio"/>

The seamless flow of data plays an important role in increasingly digitalized product development processes (Industry 4.0). The GDE interface is a machine interface that is supported by many machine tools and gear measuring machines. The interface is an XML-based file in which the data is stored. The schema of the interface is defined in VDI/VDE 2610. In addition to the geometry, the microgeometry of both flanks and the tolerances can also be included in the GDE format. Measurement results, such as profiles or flank topographies, can be included in the "inspection" section of the file.

This import feature was implemented, tested, and coordinated with the mechanical engineering company KLINGELNBERG AG in FVA Research Project 839 I [1] in cooperation with the [Laboratory for Machine Tools and Production Engineering in Aachen](#). The aim is to functionally re-evaluate gears based on measured data. This opens up the possibility of measuring optimum gears in a pairing, so that geometric limiting cases balance each other out. This makes it possible to find new ways to reduce scrap.

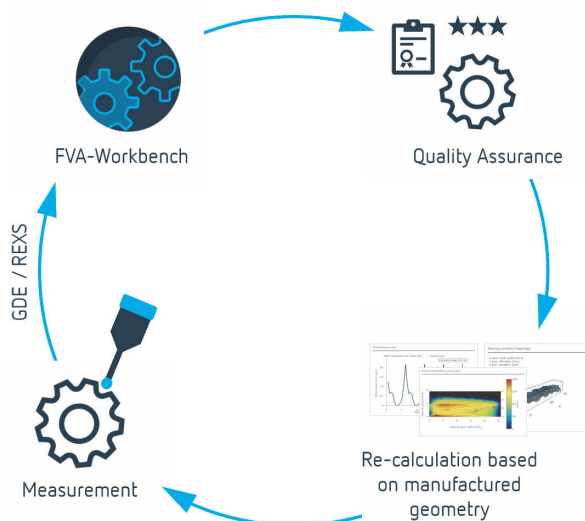

Application example: "functional closed loop" in production

Customizations to the GDE format can be added in bilateral projects with FVA Software & Service GmbH.

[List of sources \(p. 67\)](#)

Lifetime Estimation

Modeler	Extended	Advanced
✓	✓	✓

The results of the FVA 485 series of research projects [1], developed at the [Institute for Plant Engineering and Fatigue Analysis](#) at TU Clausthal, provide easy access to various methods on the subject of durability and statistic evaluation of tests. Load spectra and Wöhler S-N curves are output as results.

Load spectra

Load spectra can be quickly and intuitively designed using this module. Users can create load spectra or rainflow matrices from measurements, or synthetic load spectra can be generated from parameters. Input checks and context-sensitive help provide assistance along the way. Load spectra can also be edited to accelerate calculations. For example, values below the fatigue limit can be removed.

Wöhler S-N curves

Wöhler lines can be created for various applications. These can be based on measurements from endurance tests; however, methods from the FKM Guideline can also be used for local Wöhler lines or for screws. Artificial neural networks were created in FVA Research Project 380 [2] for precise evaluation of measurements.

Service life

Fatigue strength can be analyzed according to Hück or the maximum likelihood method. The result is a thorough statistical evaluation of the mean fatigue strength, the standard deviation, and the fatigue strength profiles for 90% and 10% survival probability of a component.

Approval testing

The approval test feature can be used to prepare service life tests, which can be used to determine the number of tests required for a specified degree of confidence from the expected statistical distribution (normal distribution, log-normal distribution, or Weibull distribution). The maximum probability of failure and the number of available samples can also be used to determine the test parameters.

[List of sources \(p. 67\)](#)

Power Flow [SYS_100.1]

Modeler	Extended	Advanced
✓	✓	✓

This module calculates the power flow based on graph theory, regardless of the complexity of the transmission system. The speeds, torques, directions of rotation, and the loaded flanks are determined in the power flow. Uniform power distribution is assumed for power splitting; for example, as used in planetary gears. Different shift positions can be defined for manual transmissions. Couplings can be opened or closed for each gear via a shift matrix.

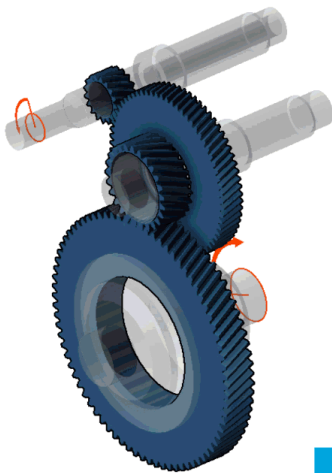

1. Gear

Representation of the power flow in the FVA-Workbench 3D View

The calculation is automatically performed when the power flow changes. Thus, the power flow is always consistent and available for the system calculation. The results can be clearly read in the power flow editor or documented in reporting.

Efficiency and Temperature - FVA 69 [SYS_200.1]

Modeler	Extended	Advanced
		✓

In today's environment, reliable gear designs are no longer sufficient. Climate change and CO2 reduction demand highly efficient gears.

With this module, the FVA-Workbench makes it possible for users to quickly and easily calculate and optimize gearbox losses early in the development process using proven FVA methods.

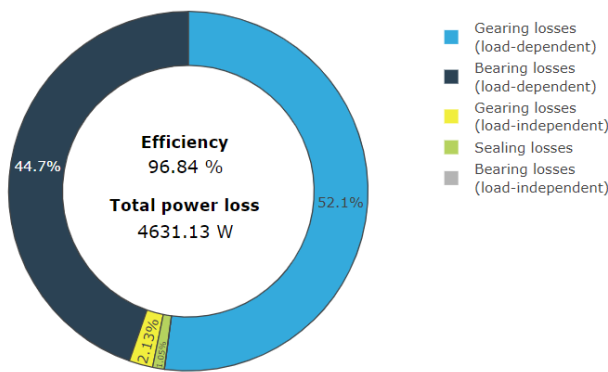

The calculation includes determination of the losses in the power flow of the gearbox.

An iterative process is then used to determine the load-dependent and load-independent gear losses, starting with the determination of the load-free forces and speeds.

The power loss calculations in the FVA-Workbench are based on FVA Research Project 69 [1], which was performed at the [Lehrstuhl für Maschinenelemente der TU München \(FZG\)](#) (Chair of Machine Elements, TUM School of Engineering and Design, Technical University of Munich).

Representation of the different loss amounts in the gearbox

The losses can be calculated according various methods for the following machine elements:

Cylindrical, bevel, and hypoid gear stages

Cylindrical, bevel, and hypoid gear stage losses are divided into load-dependent losses (friction losses) and load-independent losses (squeeze, splash, pulse, and ventilation losses). Different methods can be selected for determining the gear friction and load-independent gearing losses.		
	Cylindrical stages	Bevel and hypoid stages
Load-dependent losses		
Tooth loss factor	Ohlendorf [2]	Wech [4]
	Talboom (company publication)	
	Local geometric tooth loss factor [3]	
Friction coefficient	Schlenk [5]	Wech [4]
	Doleschel [6]	
Load-independent losses		
Immersion lubrication	Squeeze and splash losses according to Mauz [7] and Walter [8]	
Injection lubrication	Squeeze losses according to Mauz (vt < 60m/s) and Butsch (vt > 60m/s)	
	Pulse losses according to Ariura (vt < 60 m/s) [10] and Butsch (vt > 60 m/s) [11]	
	Ventilation losses according to Maurer [9]	
Worm gear stages	The losses for worm gear stages can be calculated according to either DIN 3996 or FVA Research Project 729 [12], depending on the material combination.	

Rolling bearings	The load-dependent friction losses and load-independent splash losses in rolling bearings are calculated according the manufacturer's catalog method. The formulas from ISO 14179 are used for user-defined bearings.
Seals	Radial shaft sealing losses are dependent on the speed of rotation, diameter, and type of seal, and can be calculated according to ISO 14179-1 or 14179-2.
Planet carriers	Planet carrier splash losses are determined based on FVA Research Project 313 [21].
Plain bearings	Thrust and journal bearing losses can also be considered in the power loss calculation. This requires the following modules: Journal Bearing Simulations - FVA 577 [GL_200.1] and Thrust Bearing Simulations - FVA 668 [GL_200.2].

Determination of heat transfer

Heat dissipation can be specified for the following positions:

- Gearbox casing (heat flow or convection and radiation)
- Foundation (heat flow or heat conduction)
- Shafts and flanges (heat flow or heat conduction)
- External cooler (heat flow or oil volume flow and temperature difference)

A detailed description of the methods and calculation formulas is documented in the FVA-Workbench Knowledge-Base. [German](#) | [English](#)

[List of sources \(p. 67\)](#)

Cylindrical Gear Geometry and Load Capacity - FVA 241 [ST_100.1]

Modeler	Extended	Advanced
✓	✓	✓

Cylindrical Gear Geometry Design

Cylindrical gears are the most important element of a gear unit, and it is essential that all details can be analyzed. With the FVA-Workbench, gear geometries can be defined with minimal specifications or determined with full details in a rolling contact simulation using tools. If the geometry is described in sufficient detail, meaningful results can be obtained from the subsequent standard load carrying capacity calculations or the local calculation methods (e.g., Cylindrical Gear Local Tooth Root Stress - FVA 732 [ST_200.6]).

Production-relevant geometries and tolerances are calculated according to DIN 3960 and DIN/ISO 21771-1. The dimensions of the gear and the location of the root and tip circle diameters can be determined according to these calculation rules. The tolerances for the gear are calculated according to DIN 3961 and the applicable normative references.

Representation via the standard geometry is often not sufficient for evaluation of the actual geometry. This is especially true if grinding notches are to be expected in the manufacturing process. Manufacturing processes with up to two tools can be simulated in the rolling contact simulation.

For rack-shaped tools, the tip chamfer angle at the tool, protuberance, machining allowances, different dimensioning lines, and tools with deviating pressure angles can be considered.

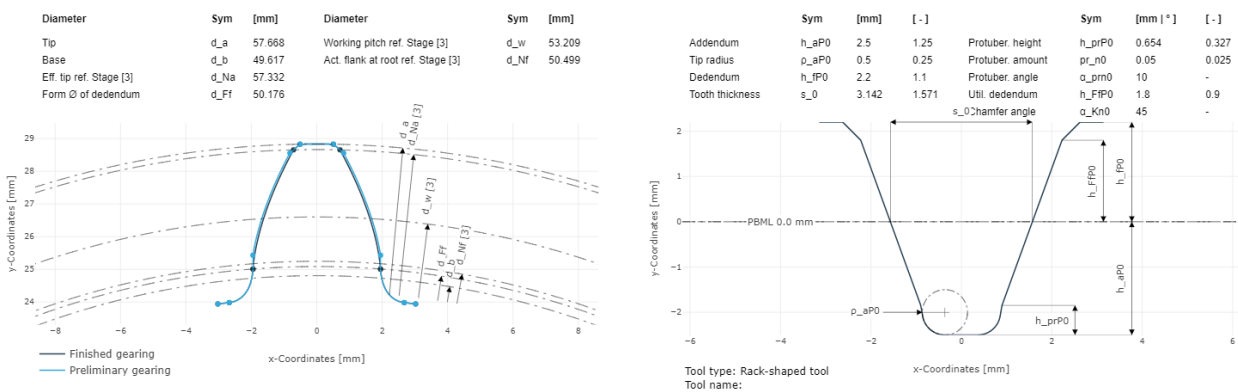

Representation of a tooth after preliminary and finish machining. The representation is based on the hobbing of the preliminary and finishing tools.

Rack-shaped tools and cutting wheels with chamfer angle and protuberance can be simulated in the calculation. Deviations and tolerances can be specified and considered according to ISO 1328 or DIN 3991 as well as applicable normative references.

The tooth contact is calculated, specific sliding speeds are determined, and checks for meshing interference are performed using the detailed gear tooth geometry.

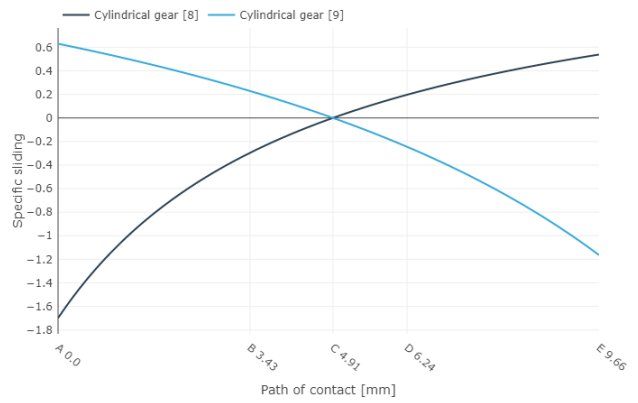
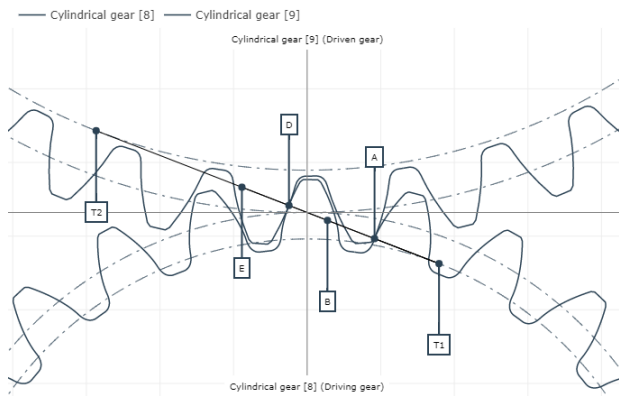

Tooth contact

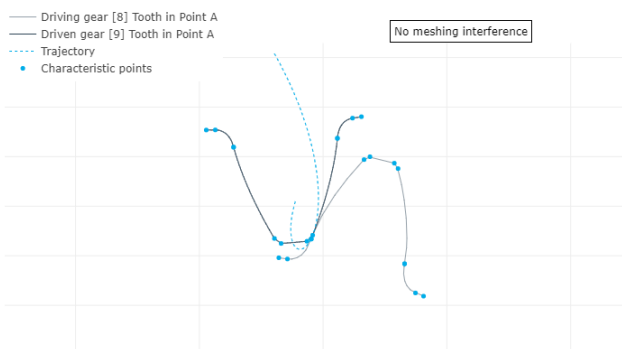

Trajectory of the mating gear tip relative to the start of engagement in the tooth root of the driving gear (point A)

Specific sliding

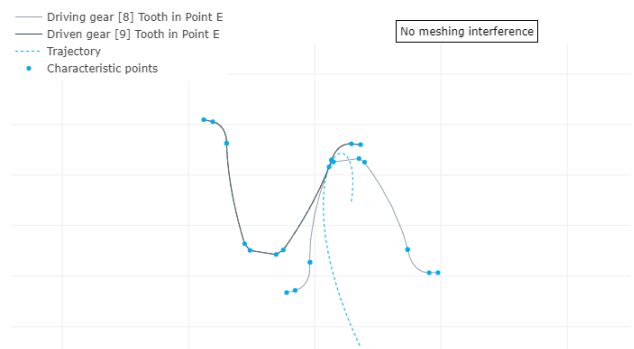

Trajectory of the mating gear tip relative to the engagement end in the tooth root of the driven gear (point E)

Checking for interference at point A

Checking for interference at point E

Cylindrical Gear Load Carrying Capacity

The load carrying capacity of cylindrical gears can be calculated according to the DIN 3990 (1987), ISO 6336 (2006 and 2019), and AGMA 2101 D04 (2016) standards. Additional damage mechanisms can also be analyzed in additional calculations.

These international norms contain the combined knowledge and experience of research and industry. They have been extensively validated and successfully applied in gearbox development for decades.

Standard calculations can quickly and easily be performed with just a few specifications, including the macrogeometry of the cylindrical gears, the operating conditions, and material and lubricant information. Calculations can be performed for individual stages or the entire system, and calculations according to DIN, ISO, and AGMA can be performed simultaneously for all standards.

The result is safety factors, which can be used to gain important information about the load capacity of the gear under the specified load.

	Version ISO 6336	Application factor	Face load factor flank	Flank safety factor	Root safety factor
Sym.		K_A	$K_{H\beta}$	S_H	S_F
Unit	-	-	-	-	-
Cylindrical stage [3]	Cylindrical gear [8]	ISO 6336 (2019)	1.00	1.04	1.040
	Cylindrical gear [9]				2.312
				1.040	2.357

Table 2

Report table from an ISO 6336:2019 calculation

A large number of predefined report and table templates are available for all methods, each of which can be customized as needed. The report comparison feature can be used to quickly and clearly compare results. For example, this can be helpful when analyzing and evaluating differences between the ISO 6336 (2006 and 2019) standards.

In conjunction with load spectra, service lifetimes can be calculated for all stages in the system for ISO 6336 (2006 and 2019) and a collective safety can be determined.

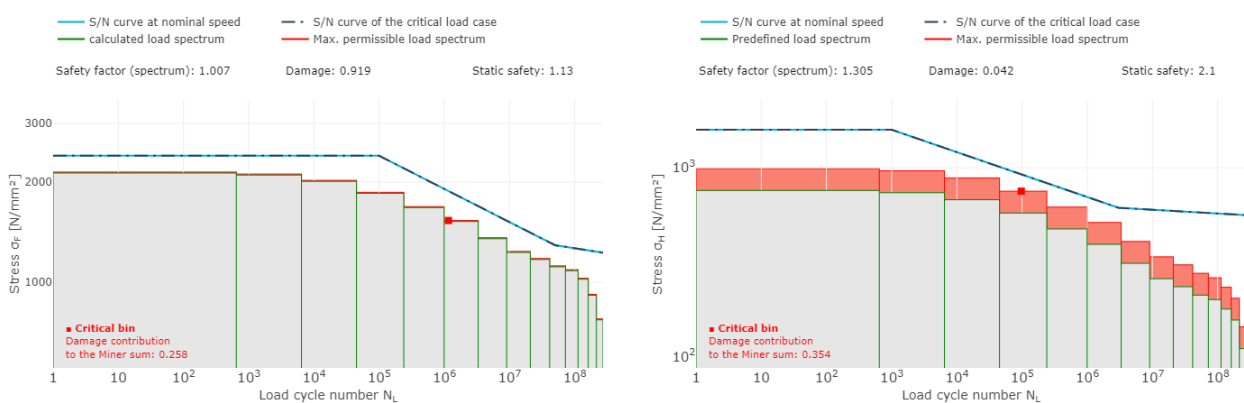

Load spectrum calculation for flank and tooth root with corresponding collective safety factors

By integrating the calculation into the overall system, all effects from the model can be included in the analysis; e.g., different face load factors or load distributions for planetary stages. The load-independent center distance can also be considered, which can lead to a change in the transverse contact ratio of soft or heavily loaded structures.

The load capacity under variable loads and/or speeds can be analyzed for DIN 3990 and ISO 6336 (2006 and 2019) in a single calculation. If variable face load factors across the load are to be considered, this must be specified.

Depending on the main standard, the calculation of various additional load carrying capacity methods (based on the standard and research) can be activated:

Additional calculations for main standards

DIN 3990 (1987) / ISO 6336 (2006 and 2019) load carrying capacity	AGMA 2101 D04 (2016) load carrying capacity
ISO 13691 application standard for the oil and gas industry	AGMA 6111 (I06)
ISO/TS 6336-20/-21:2017 scuffing calculation	AGMA 6113 (A06)
DIN 3990 Part 4 scuffing calculation	AGMA 6114 (A06)
FVA 166 scuffing calculation	API 617 (07/2002)
ISO/TR 15144-1:2014 micro-pitting calculation	API 613 (02/2003)
FVA 54 micro-pitting calculation	AGMA 925 A03 scuffing and wear calculation
IEC 61400-4 (2012) calculation for wind turbines	
ISO 6336-4:2019 flank fracture	
Plewe (1980) wear calculation	

Gear Mesh Excitation - FVA 338 [ST_200.4]

Modeler	Extended	Advanced
		○

Requirements for today's drives are constantly increasing, including demands for drives that are as quiet and low-vibration as possible. The main cause of noise and vibrations is gear excitation due to stiffness fluctuations in the gear mesh. This module can be used to perform detailed analyses and develop quiet, smoothly running gearboxes. The gear excitation calculations are based on FVA Research Project 338 I [1] and have been validated in a number of FVA projects.

The gear excitation is calculated based on the "Cylindrical Gear 3D Flank Load Distribution - FVA 30 [ST_200.2]" module and is described via the following three basic variables:

Transmission deviation ($n \rightarrow 0$), gear stiffness profile ($n \rightarrow 0$), and force excitation ($n \rightarrow \infty$).

Comparison report - unmodified vs. modified gear

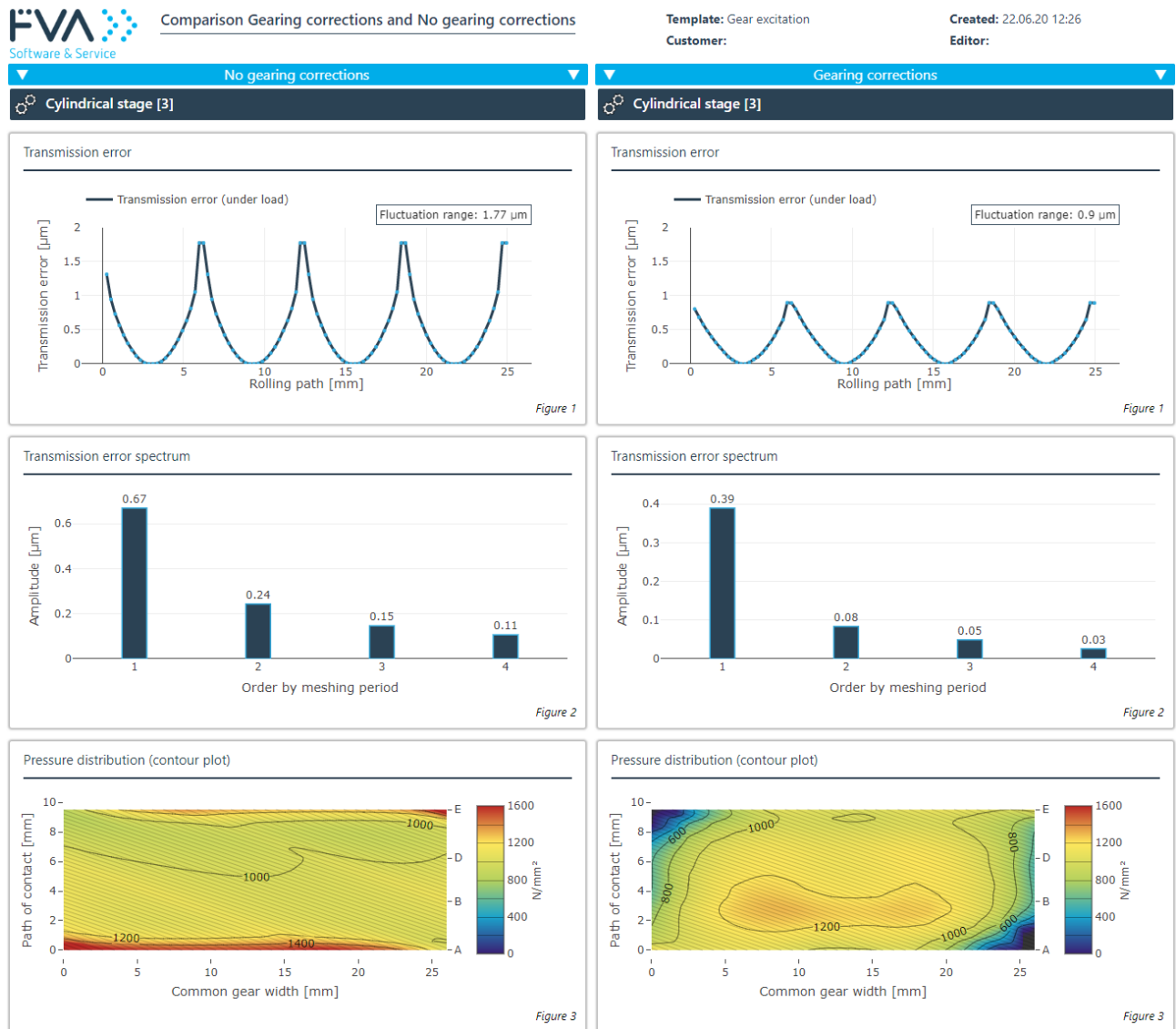

Transmission deviation, transmission deviation spectrum, and pressure distribution

By specifying a load spectrum, the profile of the excitation characteristics is calculated across different rotational torques and visualized in the report. From this visualization, important information can be determined about the

influence of the modifications on the excitation behavior of the gear, and prerequisites for optimizing the microgeometry can be established.

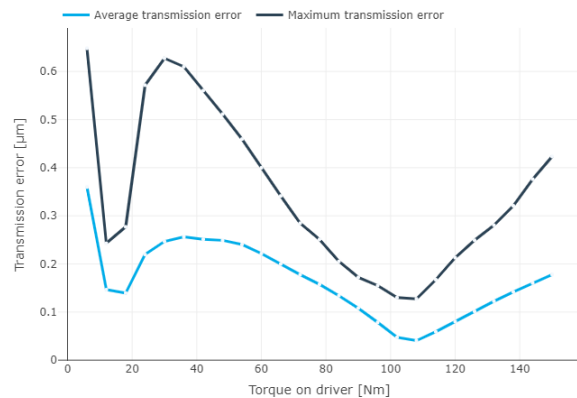
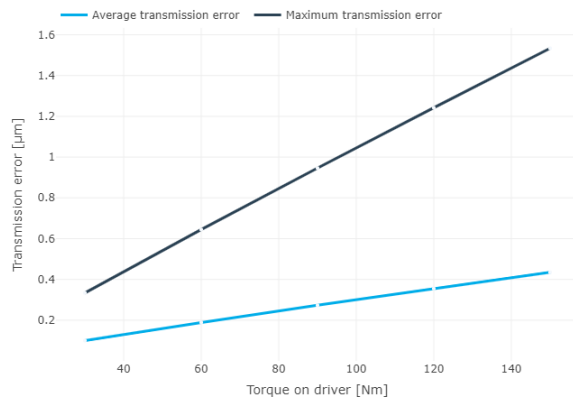

Transmission deviation of a cylindrical gear stage with and without modifications relative to torque

The excitation is primarily influenced by the main geometry of the gear, especially transverse contact and overlap ratios, early and late mesh, gear modifications (microgeometry), the load in the gear, and the deformation components in the engagement.

The load-dependent system behavior also plays a decisive role in considering the actual skewing occurring in the gear during operation due to the stiffness and flexibility of the shaft-bearing system. Similarly, the calculation of the load-independent center distance can have an effect on the transverse contact ratio and thus on the gear excitation.

The gear excitation is first calculated with a speed near zero (i.e., quasi-static), and then with a speed approaching infinity.

Speed $n \rightarrow 0$ (quasi-static)

In this case, the transmission deviation is calculated directly from the 3D load distribution and the corresponding gear stiffness is determined. The amplitudes and phase positions of the orders of the transmission deviation are determined by a harmonic analysis.

Speed $n \rightarrow \infty$

For high frequencies, masses are no longer able to perform balancing movements. Here, the rotational travel profile is constant, resulting in a variable force profile across the meshing positions. This is referred to as the force excitation of the gear. As with the transmission deviation, the amplitudes and phase positions are calculated based on the harmonic analysis.

The amplitudes of the orders can be converted into characteristic values for the excitation, for example the tooth force and excitation levels, using levels and a weighted summation. These characteristic values can be used to compare different designs. The levels evaluate the frequencies occurring, depending on audibility and intensity.

[List of sources \(p. 67\)](#)

Cylindrical Gear Classification Societies - FVA 241 [ST_200.1]

Modeler	Extended	Advanced
○	○	○

A large number of additional load carrying capacity methods are available for cylindrical and planetary gears. These mainly include methods according to international classification societies for marine applications. However, gears can also be calculated according to standards that have already been superseded. This is especially helpful for evaluating older designs.

Calculations can be performed quickly and conveniently with just a few entries, including the macrogeometry of the cylindrical gears as well as the operating conditions, and material and lubricant specifications. Single-stage calculations can be performed for one specific method or all currently implemented classification societies simultaneously. Predefined report and table templates are available for all methods, and they can be customized as needed.

The following classification societies are available:

American Bureau of Shipping (ABS), USA	Bureau Veritas (BV), France
Load carrying capacity acc. to ABS (2011)	Load carrying capacity acc. to BV (2010)
Load carrying capacity acc. to ABS (2011)	Load carrying capacity acc. to BV (2003-2006)
Load carrying capacity acc. to ABS (2004)	Load carrying capacity acc. to BV (1977)
Load carrying capacity acc. to ABS (1980)	
Det Norske Veritas (DNV), Norway	China Classification Society (CCS), China
Load carrying capacity acc. to DNV (2012)	Load carrying capacity acc. to CCS (1996)
Load carrying capacity acc. to DNV (2003)	
Load carrying capacity acc. to DNV (1990-1993)	
Load carrying capacity acc. to DNV (1978)	
Lloyd's Register of Shipping (LRS), England	Germanischer Lloyd (GL), Germany
Load carrying capacity acc. to LRS (2019)	Load carrying capacity acc. to GL (1980)
Load carrying capacity acc. to LRS (1990-2006)	Load carrying capacity acc. to GL (1998-2006)
Load carrying capacity acc. to LRS (1990-2006)	Load carrying capacity acc. to GL (1980)
Load carrying capacity acc. to LRS (1978)	
Registro Italiano Navale (RINA), Italy	Russian Maritime Register of Shipping (RMS), Russia
Load carrying capacity acc. to RINA (2004-2006)	Load carrying capacity acc. to RMS (2005-2015)
Load carrying capacity acc. to RINA (1982)	
Additional standards	
Load carrying capacity acc. to AGMA 2101 C95 (2004)	Load carrying capacity acc. to ISO 6336 (2006) – (STplus)
Load carrying capacity acc. to AGMA 2001 C95 (1995)	Load carrying capacity acc. to ISO 6336 (1996)
Load carrying capacity acc. to AGMA 2001 B88 (1989)	Load carrying capacity acc. to DIN 3990 (1970)
Load carrying capacity acc. to AGMA 421.06 (1969)	Load carrying capacity acc. to Henriot (1976)
Load carrying capacity acc. to AGMA 210.02 (1965/66)	Load carrying capacity acc. to Niemann (1965)
Load carrying capacity acc. to BS 436 (1940)	

Cylindrical Gear 2D Flank Load Distribution - FVA 30 [SYS_100.3]

Modeler	Extended	Advanced
	✓	✓

The line load distribution is a direct result of the system calculation and forms the basis for a detailed analysis of the damage mechanisms and an optimal design of the gear modifications. The applied modification is considered as the primary influence. The face load factors K_{HB} and $K_{F\beta}$ are calculated from the load distribution and passed on to the standard calculation.

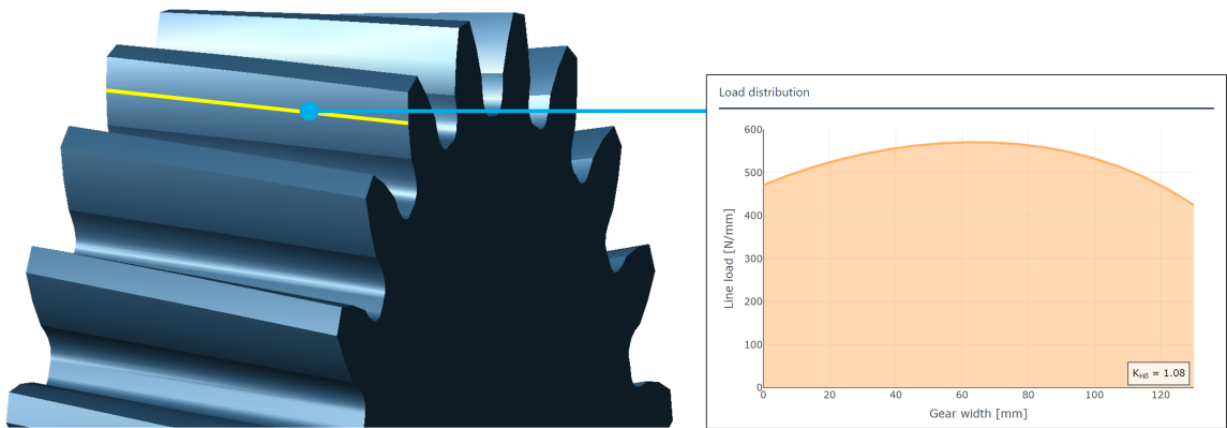

Line load distribution

The deformation of all system-relevant components is determined for calculation of the proposed modifications. The influence of the shaft bending line on the deviations, and therefore the contact pattern, are fully considered throughout the system. The bearing operating point is calculated iteratively for this purpose, taking all cross influences into consideration.

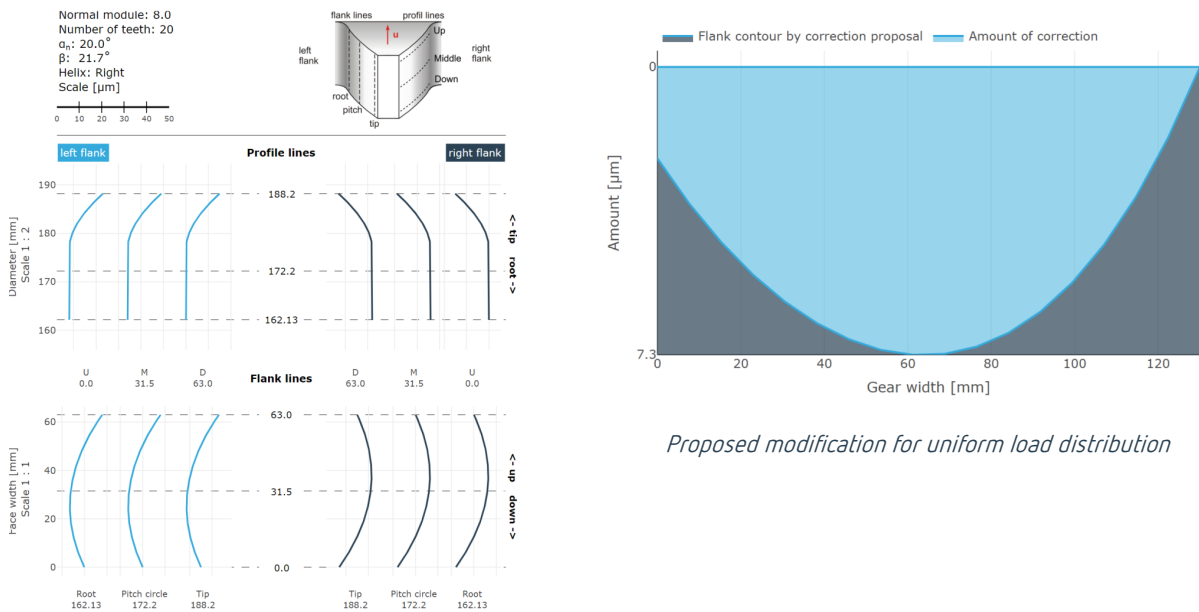

Proposed modification for uniform load distribution

Representation of the applied gear modification

Cylindrical Gear 3D Flank Load Distribution - FVA 30 [ST_200.2]

Modeler	Extended	Advanced
		✓

In the load distribution calculation, the line loads for every path of contact and the Hertzian contact stress due to the local equivalent radii of curvature are calculated based on the gear stiffness according to Weber/Banascheck [1] and Schmidt [2]. These calculations form the basis for the design of the profile and width modifications and for various load capacity calculations.

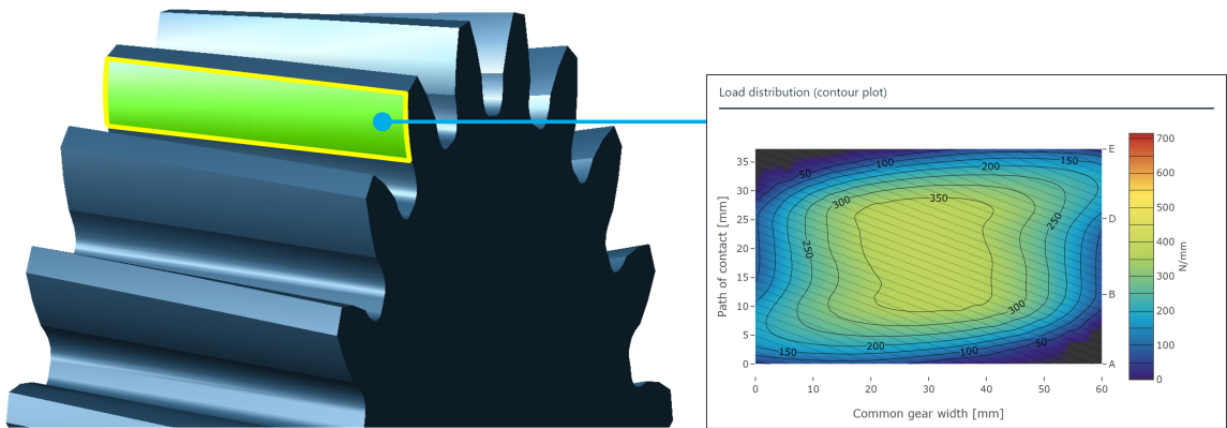

3D load distribution

The gear geometry and the load-dependent Hertzian flattening are considered in the stiffness calculation, as are the gear modifications and deformations in the tooth mesh from the overall system.

x-Axis: Common gear width [mm]
 y-Axis: Path of contact [mm]
 z-Axis: Modification proposal [μm]
 Modification criterion: Linear pressure increase

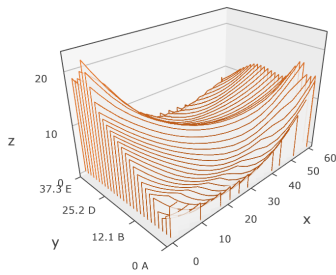

x-Axis: Common gear width [mm]
 y-Axis: Path of contact [mm]
 z-Axis: Pressure distribution [N/mm^2]

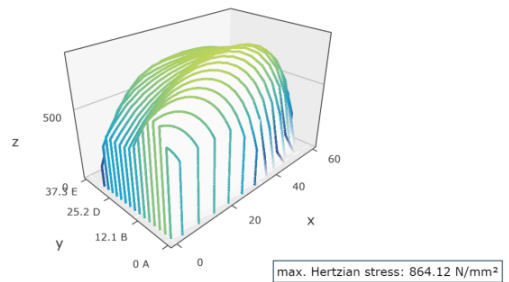

3D proposed modification

3D pressure distribution on the flank

The 3D load distribution is used for the design of targeted flank modifications. Flank modifications are used to achieve an optimal line load and pressure distribution for a specific application, and can compensate for load increases at the start and end of the mesh as well as any gear misalignment. Premature and late mesh are also considered in the 3D load distribution calculation and can be influenced with targeted flank modifications. The FVA-Workbench supports the user by calculating a 3D proposed modification. Various correction criteria can be selected (e.g., uniform pressure distribution).

Damage mechanisms

Pitting

The flank load capacity of a cylindrical gear is essentially determined by the contact pressure. The risk of pitting of a gear can be assessed by analyzing the local pressure distribution.

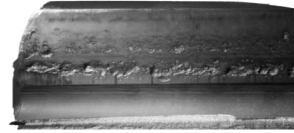
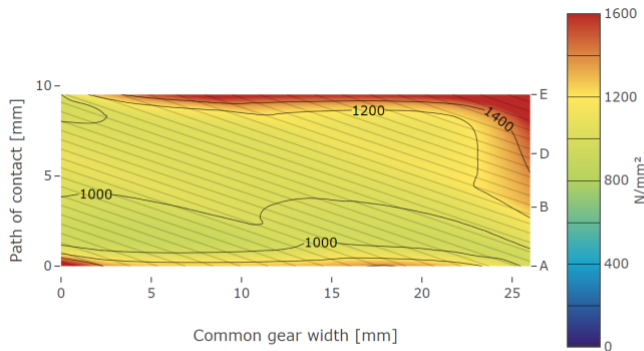

Scuffing

The flash temperature distribution is essential for assessing the scuffing load capacity. In the FVA-Workbench, the local flash temperature is calculated according to ISO/TR 15144.

x-Axis: Common gear width [mm]
y-Axis: Path of contact [mm]
z-Axis: Flash temperature [°C]

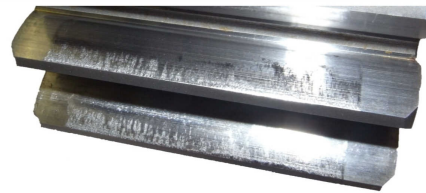
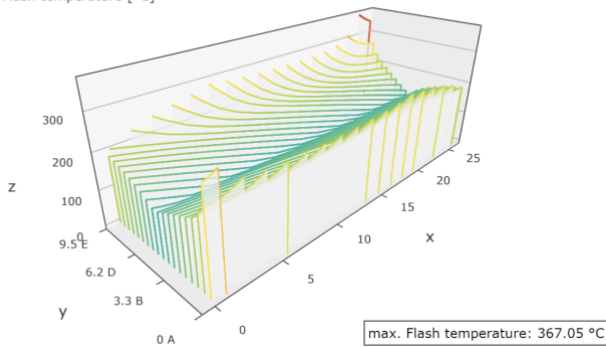

Micro-pitting

With the FVA-Workbench, the local safety against micro-pitting can be calculated according to ISO/TS 6336 Part 20/21. Intermediate results, such as the local lubricant film thickness and the sliding speed, are also output to assist with the evaluation of the calculation results.

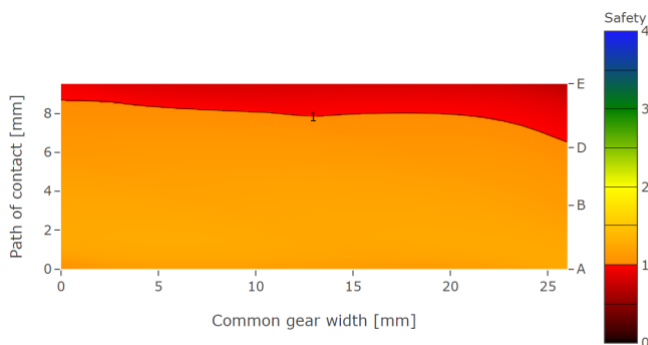

[List of sources \(p. 67\)](#)

Cylindrical Gear 3D Flank Load Distribution - FVA 127 [ST_200.3]

Modeler	Extended	Advanced
		✓

The FEM (finite element method) tooth contact analysis is based on the results of FVA Research Project 127 [1], which was developed at the [Laboratory for Machine Tools and Production Engineering \(WZL\)](#) of RWTH Aachen University. The load and pressure distribution of cylindrical gear stages and derived variables can be calculated with this module.

In contrast to the "Cylindrical Gear 3D Flank Load Distribution - FVA 30 [ST_200.2]" module, the stiffness of the gear is determined by FE-based analysis instead of analytical approaches. A 3D mesh of the gear is created, parametrically meshed, and the boundary conditions are automatically imposed. The generated mesh features hexahedral elements and quadratic shape functions, and meets the highest demands for a stress mesh. The 3D load distribution is then propagated using the influence coefficient method with an analytical elastic spring method instead of 3D FEM contact analysis.

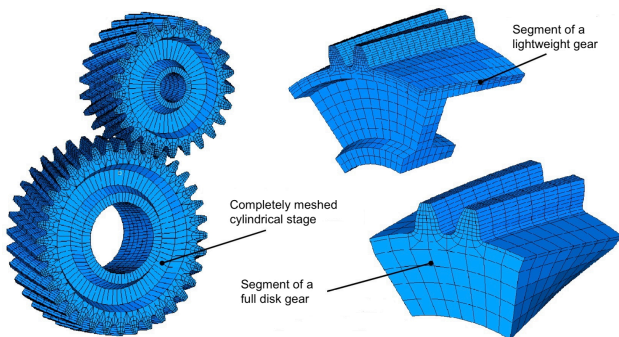

Examples of meshed cylindrical gear stages [1]

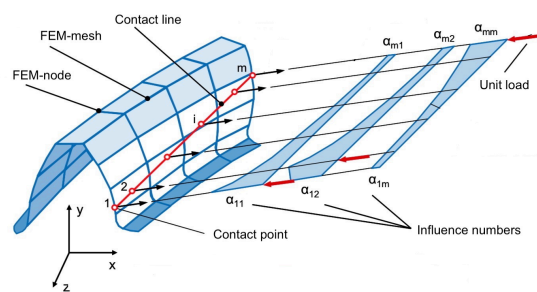

Deformation influence coefficients along the contact lines [1]

The calculation of the FEM 3D load distribution can be performed as part of a system calculation. Following the system calculation, information on the shaft-bearing system is transferred and considered as tooth trace variations. In addition to the idle running and load contact patterns, the local loads on the flanks and the stress distribution in the tooth root can be calculated and displayed.

x-Axis: Common gear width [mm]
 y-Axis: Path of contact [mm]
 z-Axis: Pressure distribution [N/mm²]

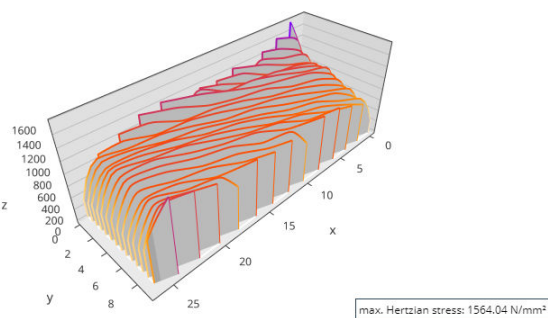

Pressure distribution on the tooth flank

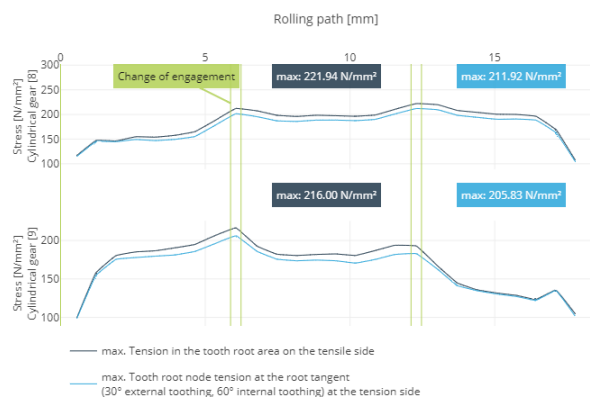

Distribution of the tooth root bending stress

The calculation also provides the following parameters for evaluating the dynamic properties of the stage:

- Rotational error profiles
- Stiffness profiles
- Fourier spectra

FEM wheel bodies

The influence of complex shaped wheel bodies can also be considered [2] in the FE tooth contact analysis. This requires the FEM Mesher (Including STEP Import) [FEM_200.1] module.

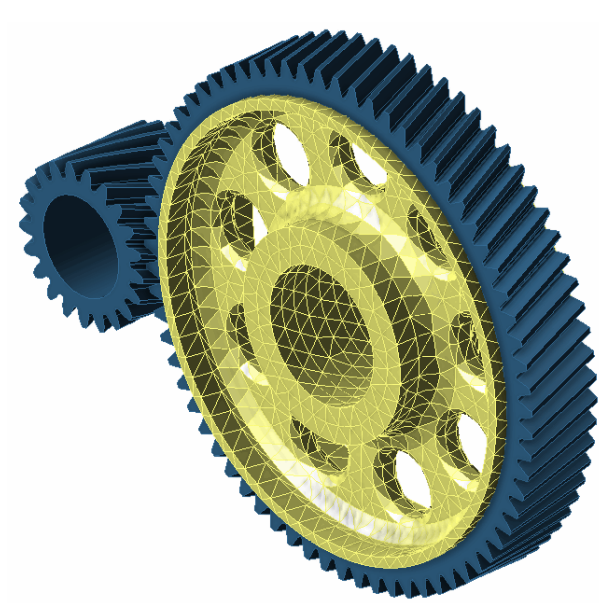

To consider the influence of circumferentially varying stiffness of complex shaped wheel bodies in the meshing conditions, wheel bodies can be imported as CAD files and meshed.

[List of sources \(p. 68\)](#)

Cylindrical Gear Local Tooth Root Stress - FVA 732 [ST_200.6]

Modeler	Extended	Advanced
		○

The calculation of the local tooth root stress according to FVA 732 [1] is used for gears where a closer examination of the tooth root stress is required. The exact tooth contour can be considered with this module, including production-related notches in the tooth root. The module calculates the tooth root stress along the face width of every gear on the drive and driven sides based on the BE (boundary element) method, and can be used for both external and internal gears. The local load distribution for the entire field of action from the "Cylindrical Gear 3D Flank Load Distribution - FVA 30 [ST_200.2]" module is used for the simulation of the local tooth root stresses.

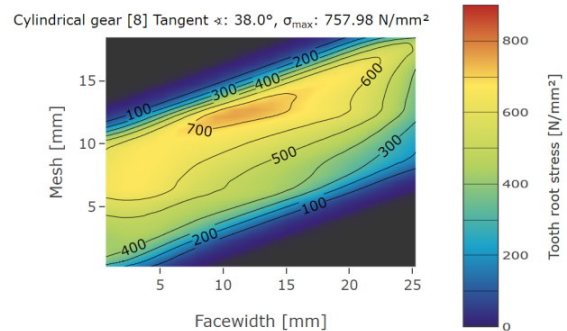
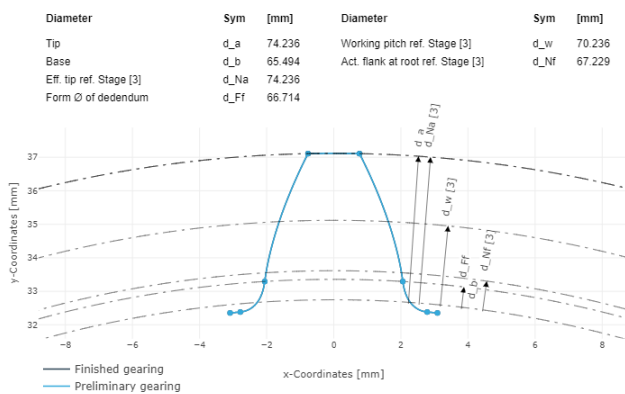

Tooth root stress for a tooth root without notch

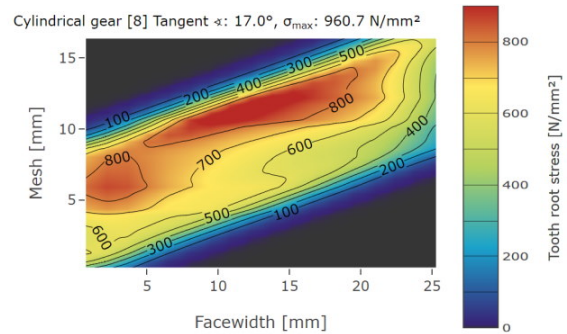
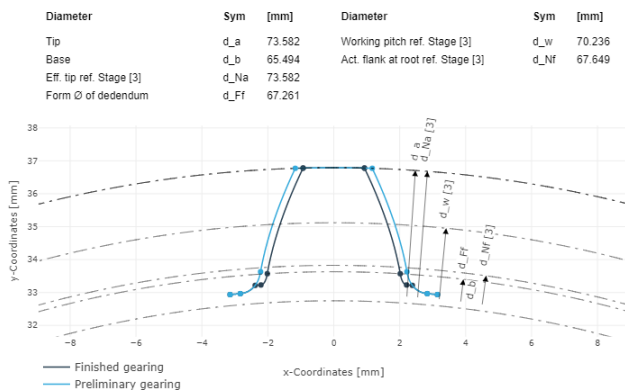

Tooth root stress for a tooth root with notch

The results for a gear with and without a notch in the tooth root are shown in the above figures. The tooth contours differ only in the root area. In this case, equal loads show the strong influence of the special shape of the tooth root, which causes excessive stress in the notch. Stresses at the 30° tangent and the tangent with the highest load can be output for both the drive and driven sides. The results for the 30° tangent can be compared with the calculation according to standard methods (ISO 6336 and DIN 3990), as these methods require a calculation at the 30° tangent.

[List of sources \(p. 68\)](#)

Plastic Gear Load Capacity - VDI 2736 [ST_100.3]

Modeler	Extended	Advanced
✓	✓	✓

Plastic gears are used in a wide variety of applications. They offer great potential for lightweight construction, in particular. Plastic is always used when weight must be reduced and the temperature and load in the gearbox are suitable. Plastic gears (cylindrical gears) can be developed and analyzed with this module, including plastic/plastic gear combinations as well as combinations of different materials, such as plastic/steel.

The methods in VDI 2736 (2014) for external gears and VDI 2737 (2016) for internal gears include initial design calculations through to detailed load carrying capacity calculations.

Initial design calculations are performed for individual stages in order to determine the necessary dimensioning of the gears. For this purpose, the required safeties as well as the ratios of face width to pinion diameter and face width to module must be specified.

The load capacity calculation can be performed quickly by specifying just a few details, including the macrogeometry of the cylindrical gears, the operating conditions, and material and lubricant data. Calculation of the load capacity for peak loads is also possible. The calculation can be performed for individual stages or the entire system.

The following values are calculated for the fatigue load:

- Tooth temperature
- Tooth root load capacity
- Tooth flank load capacity
- Wear resistance
- Deformation

Furthermore, various material characteristics, such as the modulus of elasticity, fatigue strength under pulsating stress, and rolling contact fatigue strength, can be specified as a function of the temperature via profile curves. These values can also be derived from measurement data.

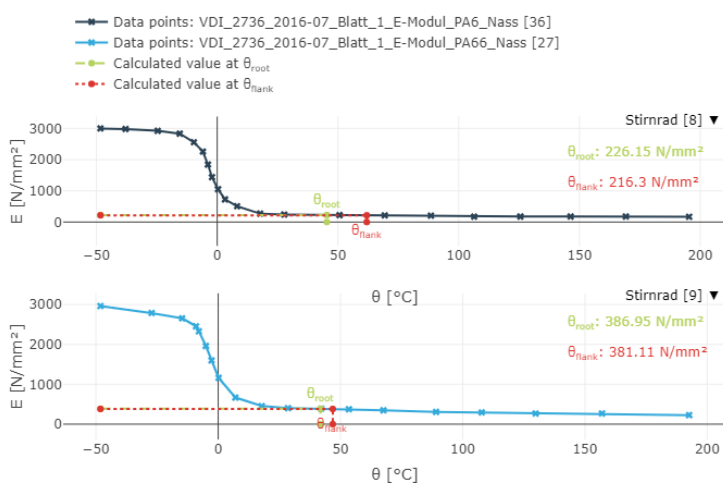

Modulus of elasticity measurement data

FE Plastic Gears [ST_200.8]

Modeler	Extended	Advanced
		✓

This module enables highly detailed calculation of cylindrical gear stages using 3D FE full contact analysis. This is particularly relevant for plastic gears, as greater deformation is to be expected due to their low stiffness. Thus, determination of the contact in a deformed state is more realistic. Any early or late meshing is taken into consideration. Complex wheel body geometries based on imported CAD geometry data can also be used. In order to be able to consider the temperature and load dependent material behavior of plastic, a stress-strain curve can be imported from a uniaxial tensile test. This is then used for hyperelastic material modeling in the FE calculation.

If desired, the shaft deformations from the system calculation can be applied as boundary conditions in the FE calculation. The FE mesh of the gears includes any applied modifications, and therefore corresponds to the actual geometry. The FE calculation is performed with the Abaqus FE solver, with all controls automated in the FVA-Workbench. Post-processing is also automated, and six key characteristics are represented in diagrams in the report: the pressures and an abrasion indicator (pressure multiplied by sliding speed) on the flanks, the damage-equivalent threshold stress, mean stress, deflection stress, and the strain in the tooth root area.

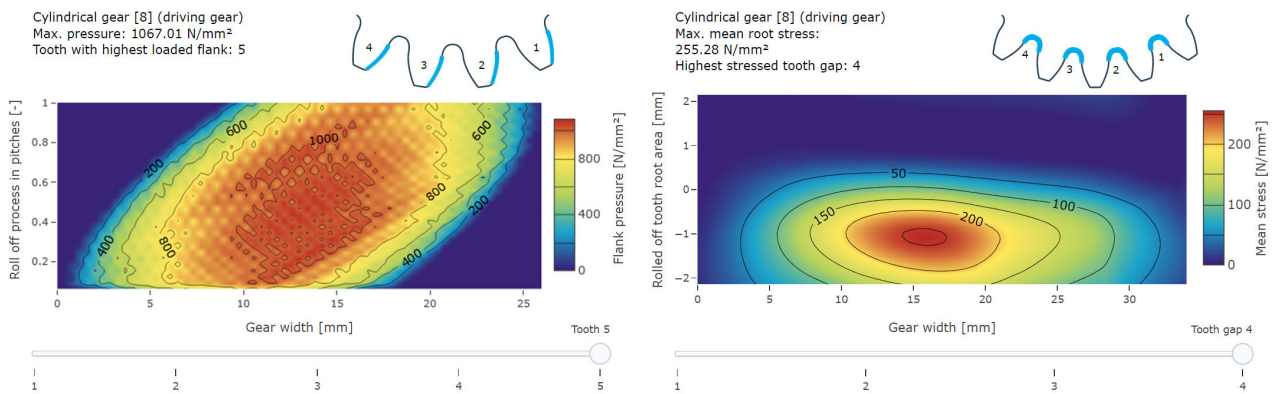

Flank pressure of all flanks from an FVA-Workbench report.

Mean stress of all tooth roots

The FE mesh of the gears and the wheel body can be seen, and the meshing steps can be evaluated in the "FEM post-processor" view.

The Abaqus calculation can also be performed on an external cluster. To do so, the complete Abaqus input file can be exported, and then the result-ODB file can be returned to the FVA-Workbench for post-processing.

Plastic-plastic, steel-plastic, and also steel-steel gear pairings can be calculated.

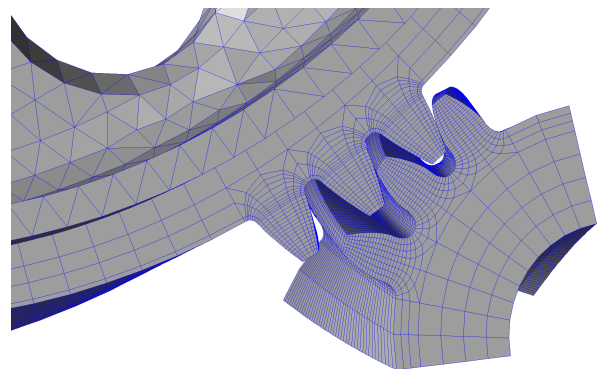

Abaqus meshes in the FVA-Workbench FEM post-processor.



This module has increased hardware requirements. A minimum of 16 GB RAM is required, 32 GB RAM is recommended.

Bevel Gear Load Capacity [KS_200.1]

Modeler	Extended	Advanced
<input type="radio"/>	<input type="radio"/>	<input type="radio"/>

The FVA-Workbench offers a large number of calculation methods for analyzing the load capacity of bevel and hypoid gear sets. Current and preceding versions of national and international standards can be used. Furthermore, methods such as the calculation of the wear resistance, efficiency, tooth forces, scuffing resistance, and the risk of micro-pitting and flank fracture can be applied. Many of the current calculation methods were developed in FVA research projects and have been validated in the corresponding test series. [1]

The only required input parameters for standard calculation methods are the macrogeometry of the bevel gear, the operating conditions (consisting of the speed, rotational torque, and operating mode), and tool and lubricant specifications. These load capacity analyses serve as a suitable foundation for conversion of the bevel gear geometry into an equivalent cylindrical gear, which approximately simulates the meshing conditions of the bevel gear to be calculated. The result is safety factors which can be used to determine important information about the load capacity of the gear under the specified load.

The following calculations can be used for recalculation of hypoid gears as well as non-axially offset bevel gears:

- Determination of equivalent cylindrical gears for bevel and hypoid gears according to various methods
- Calculation of load carrying capacity acc. to ISO 10300 (2014 edition)
- Calculation of load carrying capacity acc. to FVA 411 (2008) [2]
- Calculation of load carrying capacity acc. to Niemann/Winter (1986)
- Calculation of load carrying capacity acc. to Niemann Volume 2 (1965)
- Risk of flank breakage acc. to FVA 240-II [3]
- Risk of flank breakage acc. to Witzig /Boiadjev from FVA 556 III [6]
- Micro-pitting resistance acc. to FVA 516 (2011) [4]
- Scuffing load capacity acc. to FVA 519 (2013) [5]
- Scuffing load capacity acc. to ISO/TS 6336-20 (follow-up to ISO/TR 13989-1, 2000 edition)
- Scuffing load capacity acc. to ISO/TS 6336-20 (follow-up to ISO/TR 13989-2, 2000 edition)
- Calculation of efficiency and power loss acc. to Wech (1987)
- Calculation and output of gearing forces

The following calculation rules are also fully valid for recalculation of non-axially offset bevel gear units:

- Load carrying capacity calculations acc. to ISO 10300 (2001)
- Load carrying capacity calculations acc. to DIN 3991
- Wear calculation acc. to Niemann/Winter

Load spectrum calculations with single-stage load spectra are integrated into the load capacity calculations according to DIN 3991, ISO 10300 (2014), AGMA-C10, and FVA 411, and can optionally be activated for system and individual stage calculations.

[List of sources \(p. 68\)](#)

Bevel Gear Classification Societies - FVA 49 [KS_200.2]

Modeler	Extended	Advanced
○	○	○

In addition to the standard calculation methods, the rules of marine classification societies and AGMA can also be calculated with this module [1].

The macrogeometry parameters of the bevel gears, the operating conditions, and material and lubricant data must be specified to perform the calculation.

The following current calculation methods are available:

- Load carrying capacity acc. to AGMA 2003-C10
- Load carrying capacity acc. to American Bureau of Shipping 2016
- Load carrying capacity acc. to Bureau Veritas 2014
- Load carrying capacity acc. to Det Norske Veritas / Germanischer Lloyd 2015
- Load carrying capacity acc. to Lloyd's Register 2015
- Load carrying capacity acc. to China Classification Society 2015
- Load carrying capacity acc. to Russian Maritime Register of Shipping

In addition, the following calculation methods of previous editions are also available:

- Load carrying capacity acc. to AGMA 2003-B97
- Load carrying capacity acc. to AGMA 2003-A86
- Load carrying capacity acc. to Det Norske Veritas 2003
- Load carrying capacity acc. to Det Norske Veritas 1993
- Load carrying capacity acc. to Germanischer Lloyd 1998
- Load carrying capacity acc. to Lloyd's Register 1998

In both the system calculation and single-stage calculation of bevel gear stages, the calculation according to AGMA or all currently implemented classification societies can conveniently be performed in a single calculation step. If only one bevel gear stage is to be calculated as an individual component, it is also possible to perform a targeted calculation of a single method according to the current or previous editions.

[List of sources \(p. 68\)](#)

Bevel Gear Local Load Capacity - FVA 223 [KS_200.3]

Modeler	Extended	Advanced
○	○	○

The standard calculation methods in the "Bevel Gear Load Capacity [KS_200.1]" module provide a simplified description of the complex meshing conditions of bevel gears. For example, the microgeometry and relative position deviations cannot be considered in these methods. However, due to the sensitivity of bevel gears to displacement, the contact pattern, which results directly from the microgeometry, plays an important role. The local bevel gear calculation methods in the FVA-Workbench provide critical support [1].

Types of bevel gears that can be calculated with the FVA-Workbench

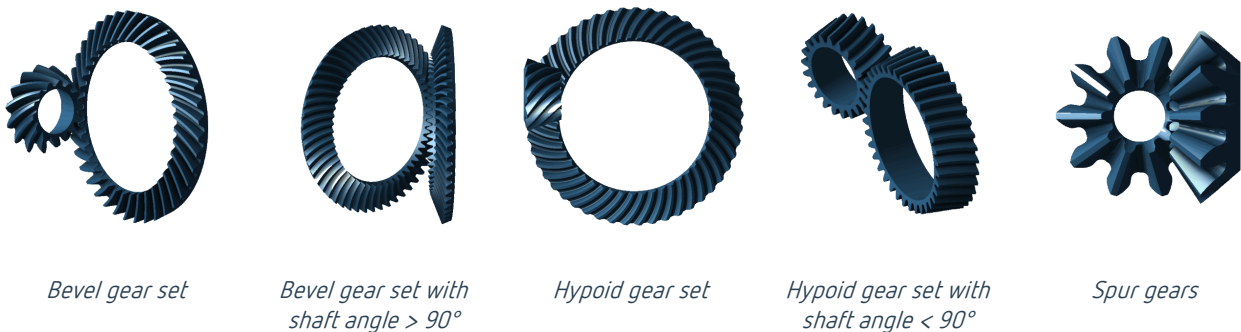

Steps for successful calculation of bevel gear stages

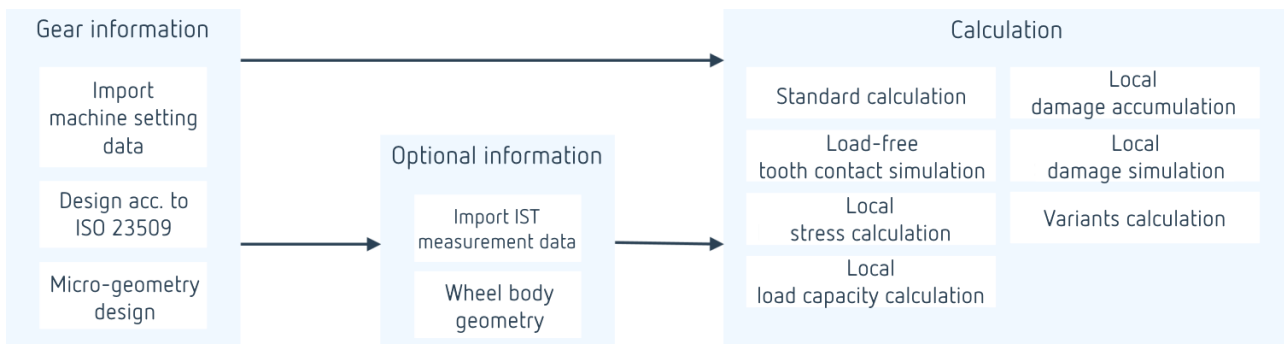

Importing bevel and hypoid gear sets

The following input paths are available for describing the geometry of bevel gears, including the microgeometry:

- Importing machine setting data for common company interfaces (basic geometry with complete machine settings)
- Importing free 3D bevel gear geometry according to the KIMoS 3D neutral data and the associated basic geometry data [1]
- Specifying the basic geometry data according to ISO 23509 [3]

Load-free tooth contact simulation

The results of the load-free tooth contact simulation form the foundation for all subsequent advanced calculations, and include important information on the effectiveness of the microgeometry design (ease-off) on the displacement behavior and meshing interference (size and location of the contact pattern). The circumferential backlash and ductility (mountability) of the bevel pinion can also be output.

max. gape size: 100 μm

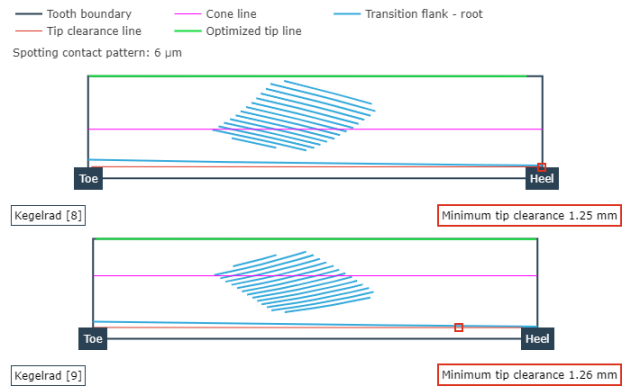
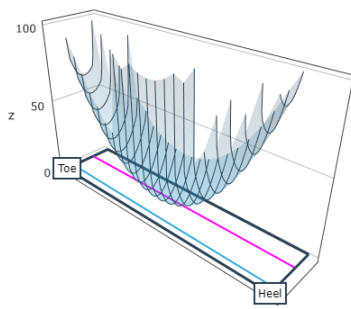

Representation of the ease-off over the crown wheel flank

Load-free contact pattern of gear and pinion

Local stress calculation

Building on the results of the tooth contact simulation, the load calculation is performed based on the influence coefficient method, a numerical calculation method which can be used to efficiently calculate the load and stress distributions at discrete locations. As a result, the user is provided with the locally solved load and pressure distribution as well as the resulting degree of efficiency and the gear stiffness profile.

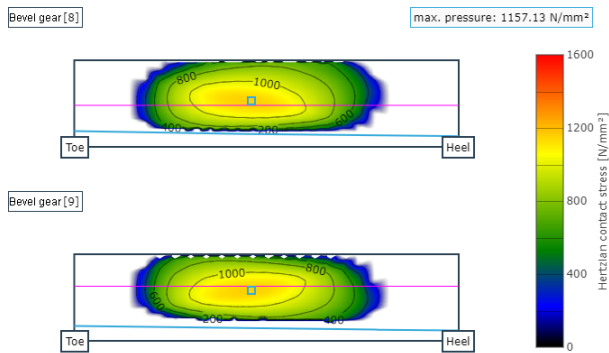

Pressure distribution on the flank

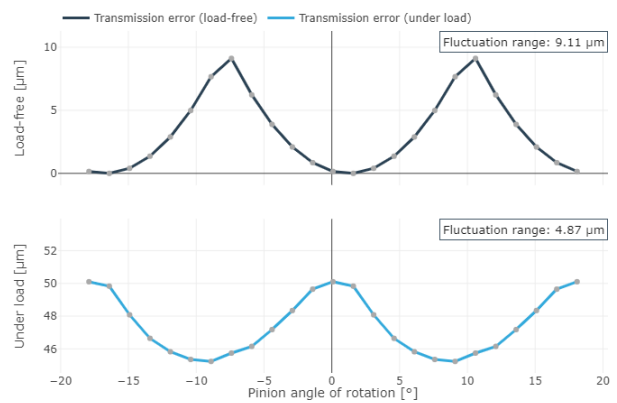

Transmission error

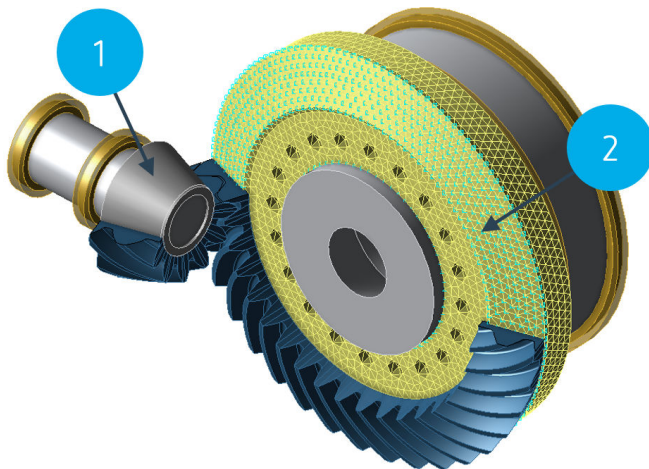

In order to correctly consider the wheel body stiffness [5], wheel bodies can either be specified parametrically using standard bodies (1) or as CAD geometry (2). The FEM Mesher (Including STEP Import) [FEM_200.1] module is required for the latter option.

Local load capacity calculation

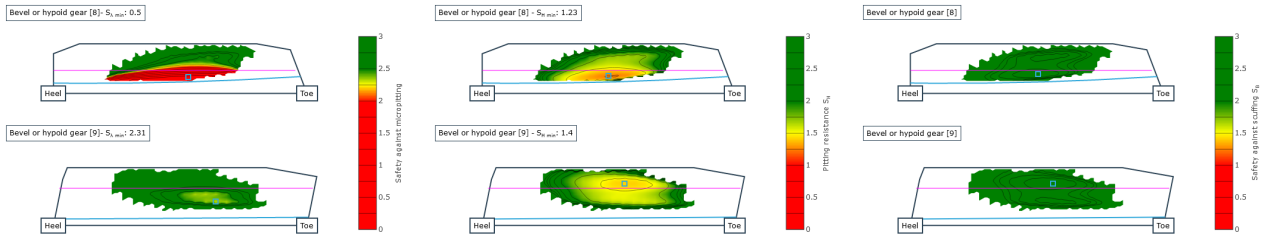

Local micro-pitting resistance [7]

Local pitting resistance [6]

Local scuffing resistance [8]

Measurement of the contact pattern

The idle contact pattern is the most significant parameter in the assembly, and can be used to set the bevel gear stage and align the bevel gears with one another. In order to be able to compare the contact pattern with the calculation, guidelines on how contact patterns can be characterized and measured were developed in FVA Project 223 XV [4].

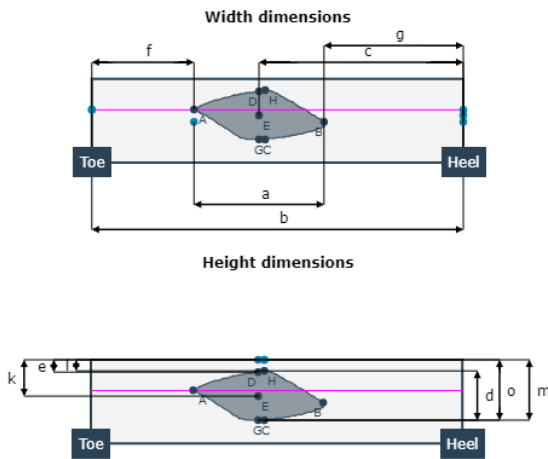

Representation of the idle contact pattern in an FVA-Workbench report

Local damage calculation in the load spectrum

With a local damage accumulation calculation, the true load conditions, which change during the operating life, can be considered in the tooth contact simulation and subsequent local load capacity calculation. This provides users with a first indication of the location of the greatest damage, and thus the area at which pitting and tooth root damage are most likely to occur, as well as an estimation of the amount of fatigue.

Variational calculations

A specific characteristic of bevel gears is their sensitivity to displacement; i.e., the change to the position and size of the contact pattern with relative position changes. Automatic variation of the speed and torque combined with load-dependent relative position changes provides a quick overview of the changing local stresses and safety factors.

Local damage simulation

In addition to the local load capacity calculation, a damage simulation [2] can be performed for the tooth flanks based on FVA Research Project 223 XII. The simulation of micro-pitting and pitting growth is based on the determination of the load capacity, the cumulative calculated damage, and the determination of the resulting flank deformation. Since the damage is caused by constant changes to the flank shape during the simulation, both the interaction between micro-pitting and pitting damage, and the influence of the damage on the load capacity of the flank can be represented.

[List of sources \(p. 68\)](#)

Worm Gear Load Capacity - FVA 320 [SN_200.1]

Modeler	Extended	Advanced
<input type="radio"/>	<input type="radio"/>	<input type="radio"/>

This module for standard load capacity calculation of worm gear stages was developed in FVA Research Project 320 [1] at the TU Munich [Institute of Machine Elements \(FZG\)](#). It can be used to perform the following load capacity verifications in the FVA-Workbench:

- DIN 3996 (1998)
- DIN 3996 (2012)
- ISO TR 14521 (2010)
- AGMA 6034
- BS 721
- FVA Research Project 320 IV (precursor to DIN 1996) [2]
- FVA Research Project 141 (Scuffing Load Capacity) [3]
- FVA Research Project 12IV (Calculation of Service Life) [4]
- FVA 205 (Wear) [5]
- FVA 465 (Wear) [6]

A load and speed collective can also be considered for the wear resistance and tooth root calculations.

The calculation module also delivers the test dimension X for the ZA, ZN, ZI and ZK flank shapes for the so-called three-wire measurement method, which is often used to measure the geometry of screws.

[List of sources \(p. 42\)](#)

Worm Gear Local Load Capacity - FVA 320 [SN_200.2]

Modeler	Extended	Advanced
		○

This module includes calculation methods which can be used for the ZA, ZN, ZI, ZK, and ZC flank forms that go beyond pure standard load capacity calculations.

Load distribution and contact pattern

The calculations are based on methods that were developed at the [TU Munich Institute of Machine Elements \(FZG\)](#) [1]. The following local stresses in the tooth contact of worm stages can be calculated:

- Load and no-load contact pattern
- Sliding speed
- Sum of velocities
- Line loads
- Contact stress
- Equivalent radii of curvature
- Lubricating film thickness
- Damage sum
- Wear erosion
- Tooth root bending stress

A load and speed spectrum can be considered for calculation of the contact pattern development, damage sums, and wear removal.

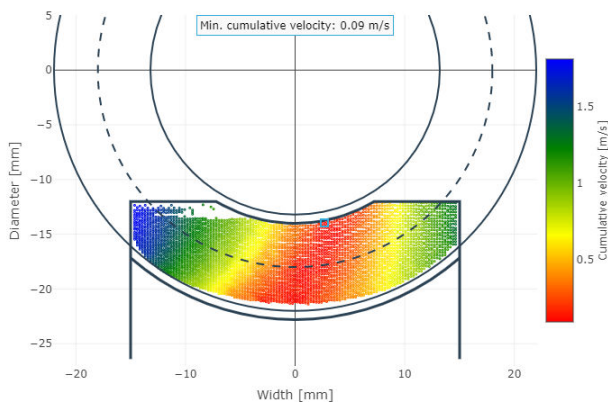

Distribution of the cumulative velocity

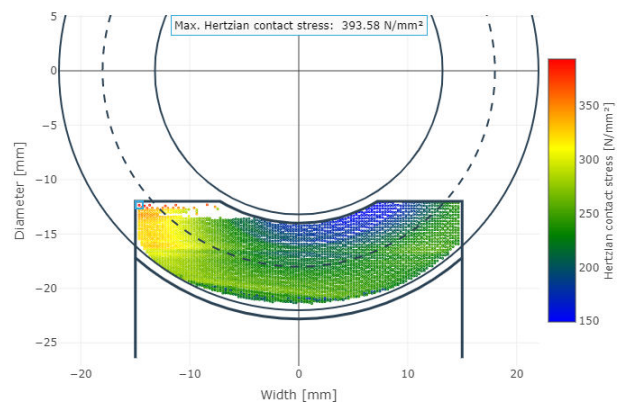

Contact stress

This calculation has been extensively validated in multiple FVA research projects [2] by comparison with test bench trials.

Lines of contact and physical characteristics

This calculation method was developed at the "Institut für Konstruktionstechnik der Ruhr-Universität Bochum" [3], and uses a simplified calculation of the local stress values on the flank to deliver characteristic values, made dimensionless using the center distance based on the Predki dissertation. These key parameters make simple comparison and quick optimization of different gears possible. The following key parameters are output:

- Characteristic value for average Hertzian contact stress ρ_m^*
- Characteristic value for maximum Hertzian contact stress ρ_{max}^*
- Characteristic value for lubricating gap height h^*
- Characteristic value for average glide path s^*

The geometry is also checked for meshing interference, and the coefficient of friction and the efficiency of the gear are determined.

Geometry design

This calculation was developed at the TU Munich Institute of Machine Elements (FZG) [4] and performs an automatic optimization of worm stages. The limit conditions for both the gear geometry and the target values can be used. An optional automatic variation of the manufacturing deviations can also be performed to consider the sensitivity of the contact pattern to manufacturing deviations during the optimization. The determined manufacturing tools can then be transferred to the FVA-Workbench tool database.

Self-braking

Worm stages can be designed so that they lock if the drive torque is disconnected or fails. This can represent an added safety element in the drive train in addition to the actual brake. While self-locking means that a worm stage at rest does not begin to move when output torque is applied to the worm gear, self-braking is a dynamic process in which the worm gear stage automatically comes to a standstill as soon as no drive torque is applied to the worm gear, but drive torque is still present.

The self-braking behavior of dynamically loaded worm gear stages can also be calculated [5]. This calculation is based on the results of FVA Research Project 260 and was developed and validated with test bench trials at the "Institut für Konstruktionstechnik der Ruhr-Universität Bochum."

Start-up efficiency

Worm stages that are designed to be self-locking have a low-efficiency by nature. This also increases the amount of start-up torque required. With the FVA-Workbench, stages of this type can be designed so that the start-up torque is kept as low as possible. Test trials were performed for this purpose in FVA Research Project 138 [6].

[List of sources \(p. 69\)](#)

Crossed Helical Gear Load Capacity - FVA 651 [SCH_200.1]

Modeler	Extended	Advanced
○	○	○

Crossed helical gears generally consist of a pair of two helical gears with intersecting axes. For larger gear ratios, an involute worm can also be combined with a helical gear. Although helical gear stages usually have a low load capacity compared to other designs, they are often used when rotational movement or positioning are the primary concern, not power transmission. The advantages of crossed helical gears can be summarized as follows [1]:

- High gear ratios
- Special axial crossing angles
- Not sensitive to installation deviations
- Low acoustic excitation
- Simple assembly
- Low manufacturing costs compared to worm gear units

In the FVA-Workbench, crossed helical gear stages can be calculated using methods from FVA Research Projects 651 [1,2] and 26 [3], which were developed at the TU Munich Institute for Machine Elements (FZG). The idle and load bearing contact patterns of the crossed helical stage are determined, taking the geometry of the gears, profile modifications, and manufacturing deviations into account.

Possible material combinations for the load capacity calculation

Borated steel/borated steel	Tempered steel/bronze	Steel/PEEK
Hardened steel/hardened steel	Tempered steel/gray cast iron	Steel/POM
Hardened steel/bronze	Gray cast iron/gray cast iron	Steel/PA4.6
Hardened steel/pearlitic cast iron	Steel/plastic	Steel/Fe1.5Mo-0,3Cu-2Cu

The integrated calculation methods and material characteristics are based on the following basic investigations:

- Load carrying capacity acc. to Niemann/Winter [4]
- Load carrying capacity acc. to Wassermann dissertation [5]
- Load carrying capacity acc. to Wendt dissertation [6]
- Load carrying capacity acc. to Hoechst company publication [7]
- Load carrying capacity acc. to VDI 2736 [8]

The following additional calculation options for the steel/plastic combination were derived from tests performed by Pech [9]:

- Average coefficient of friction
- Efficiency
- Temperature calculation
- Wear resistance
- Resistance to flank fracture
- Pitting resistance
- Deformation of plastic gears

[List of sources \(p. 45\)](#)

Rolling Bearing Calculations - FVA 668 & FVA 364 [WL_200.1]

Modeler	Extended	Advanced
○	✓	✓

From catalog calculations to local consideration of rolling contacts, the FVA-Workbench supports the user with a wide range of calculation options based on FVA Research Projects 668 [1] and 364 [2].

The level of detail of the calculation is largely dependent on the availability of the internal geometry data. If the external dimensions and load ratings are known, the rating life calculation according to DIN/ISO 281 can be performed. Manufacturer catalogs from SKF, TIMKEN, and INA/FAG are available to facilitate bearing selection. If the internal geometry is known, detailed rolling contact calculations can be performed.

Extended rolling bearing service life

The calculation of the extended rolling bearing service life according to DIN 26281 is based on the internal bearing loads, which are determined under consideration of the installation and operating conditions. The load distribution across the individual rolling elements is determined based on the shaft and bearing deformations under load. For line contact, the pressure is solved over the length of the rollers, which makes it possible to reliably determine the influence of the edge supports of the rolling element profile.

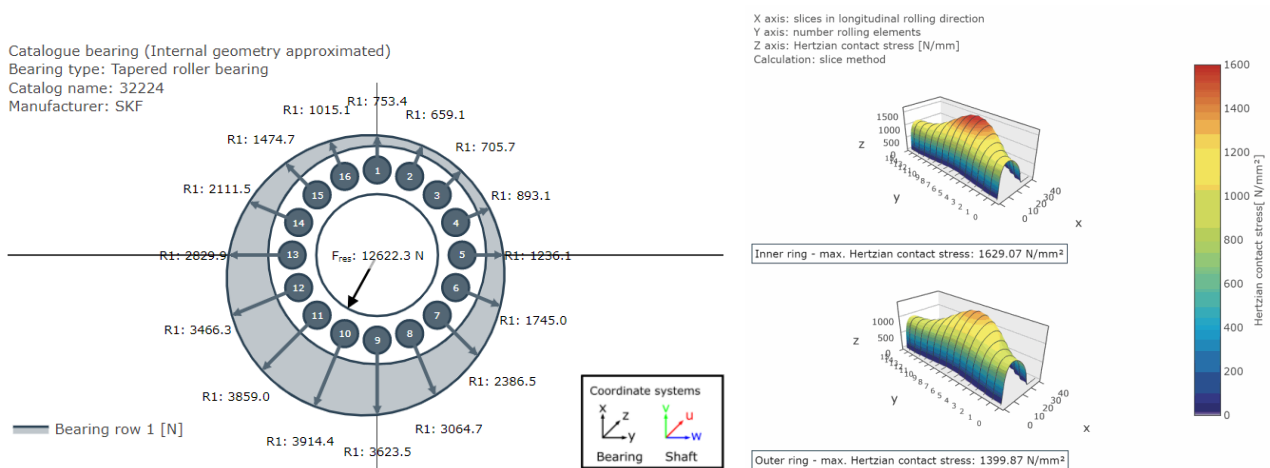

Force distribution across the rolling elements

Hertzian contact stress on the inner and outer ring

SKF Calculation Service

The SKF Calculation Service is a cloud-based solution for calculating the life and stiffness of rolling bearings. This feature makes it possible to consider the exact geometry of SKF bearings. This includes consideration of the bearing stiffness, which is determined by the SKF Calculation Service using the actual internal geometry of the bearing (size and number of rolling elements, curvature and profiling, etc.).

If the bearing life is calculated, the (extended) reference rating life according to ISO/TS 16281 is also determined by the SKF Calculation Service.

[List of sources \(p. 69\)](#)

Thrust Bearing Simulations - FVA 668 [GL_200.2]

Modeler	Extended	Advanced
○	○	○

Thrust bearings are often used with high speeds, high load dynamics, or large diameters. Due to the hydrodynamic operating principle, forces in the longitudinal direction of the shaft can be absorbed with very high damping and virtually wear-free.

Plain bearing calculations in the FVA-Workbench include all significant influences, and are based on calculation methods that were developed at the TU Clausthal "[Institut für Tribologie und Energiewandlungsmaschinen \(ITR\)](#)" [1]. This enables isothermal and temperature-dependent calculation of the static and dynamic bearing characteristics of hydrodynamically lubricated thrust bearings in single and double arrangements for fixed and tilting pad bearings.

The plain bearing geometry can be specified segment-by-segment. This makes it possible to consider radial sealing webs and segment profiles, as well as the size and location of the oil feed, including the geometry of the dirt nut groove. Deformations such as segment lowering as well as deflection of the track disc can also be considered.

The pressure calculation is based on solving the extended Reynolds differential equation. The lubricating gap flow in non-pressurized areas of the diverging gap is determined using a mass-retaining cavitation model. Centrifugal forces in the fluid, which are significant for large bearings, as well as the lubricant film turbulence are also considered.

The flow in the converging gap leads to heating of the lubricant and the bearing. Precise information about the warming of the bearing can be determined from simultaneous (iterative) calculation of the pressure, temperature, viscosity, and density distribution in the lubricating gap, and the temperature distribution in the track disc and basic segment bodies. The heat transfer boundary conditions of the bearing can also be defined in fine detail.

z-Axis: Temperature [°C]

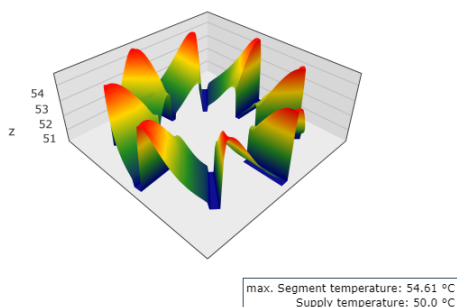

Temperature distribution in the bearing

z-Axis: Pressure [bar]

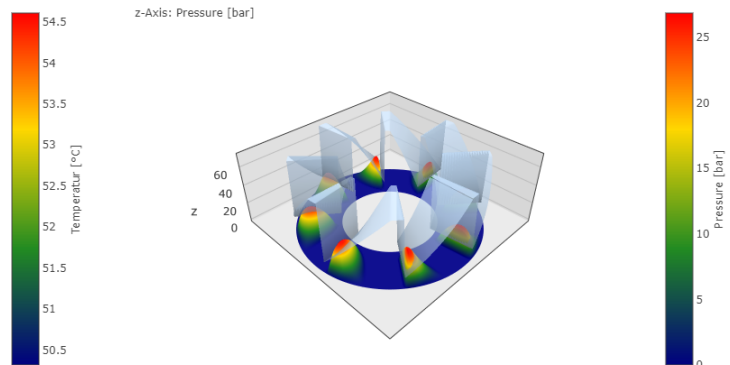

Pressure and gap thickness in the bearing

The stiffness of thrust bearings is iteratively determined in the system calculation. The tilting of the shaft and the axial force affect the rigidity of the lubricating film. This makes it possible to calculate the model in even more detail.

[List of sources \(p. 47\)](#)

Journal Bearing Simulations - FVA 577 [GL_200.1]

Modeler	Extended	Advanced
○	○	○

There is an optimum bearing type for every application. Hydrodynamic plain bearings are used for very high speeds or when increased radial damping is required. When appropriately designed, they enable long-life, low-noise, wear-free operation due to the lubricating film in the bearing. Precise simulations can ensure that the pressure is evenly distributed across the bearing shell, so that the temperature distribution is tolerable for the bearing and lubricant, and the pump is able to deliver the required volume flow.

The methods for simulation of hydrodynamic radial plain bearings were developed in multiple FVA research projects at TU Clausthal [1], and are continuously validated with the high-performance test rig at the [Institute for Tribology and Energy Conversion Machinery \(ITR\)](#).

Fixed and tilting pad bearings are simple to model in the FVA-Workbench. Even bearings with mixed segment types can easily be simulated. The additional cooling effect of a radial groove or axial seals can also be considered. The hydrodynamic pressure in the lubricant gap is calculated, taking the geometry and the specified load into consideration. To do this, the geometry is discretized and the Reynolds differential equation is solved. Two different, mass-retaining boundary conditions can be used.

In addition to the local pressure profile, the maximum pressure and volume flows across the segment can be output as key parameters. The fill level specifies the amount of lubricant still contained in the gap.

X axis: Circumferential direction [°]
Y axis: Bearing width [mm]
Z axis: Pressure [bar]

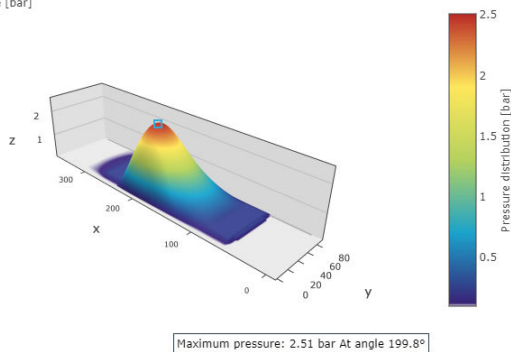

Pressure distribution at bearing circumference

X axis: Circumferential direction [°]
Y axis: Bearing width [mm]
Z axis: Temperature [°C]

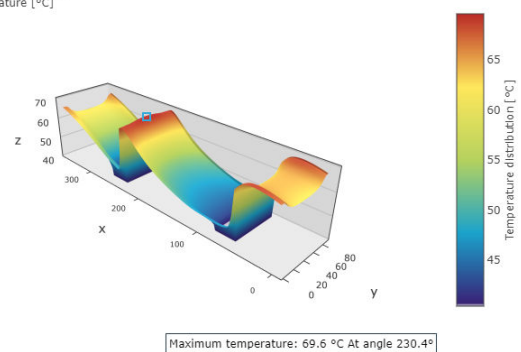

Temperature distribution at bearing circumference

The lubricant in the bearing heats up due to the fluid friction in the lubricant gap, and the conduction of the lubricant heats the shafts and the bearing shell. This heat transfer is also considered in the heat balance. Due to the change in the lubricant temperature, a new viscosity can be locally determined and the pressure can be recalculated. The change to the bearing clearance due to thermal expansion is also automatically considered.

[List of sources \(p. 69\)](#)

Shaft Load Capacity - DIN 743 & FVA 700 [WL_100.1]

Modeler	Extended	Advanced
	✓	✓

In the FVA-Workbench, the load capacity of notches on axles and shafts is calculated according to DIN 743. The underlying calculation methods were developed by the TU Wien [Institute of Engineering Design and Product Development](#).

Overlapping notches can also be calculated. The methods for calculation of multiple notches were developed in FVA Research Project 700. [2,3]

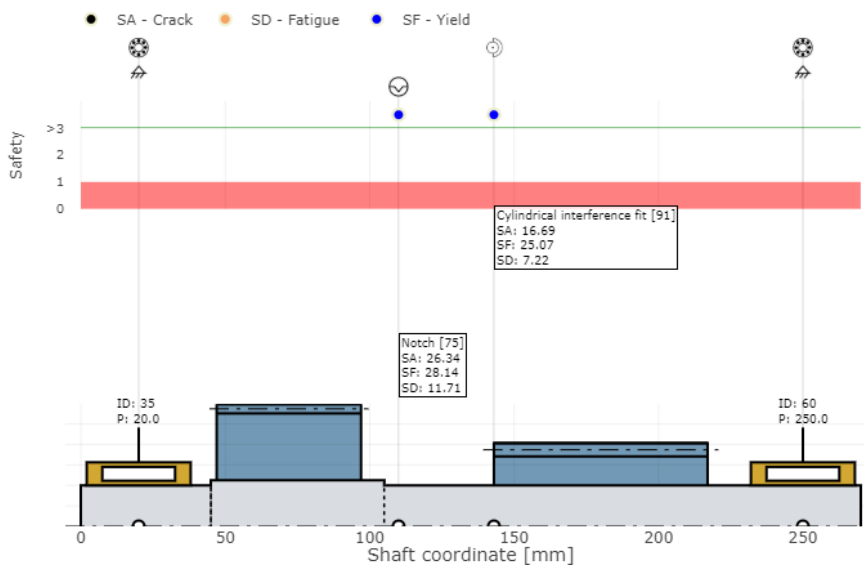

Representation of shaft safety factors according to DIN 743 in an FVA-Workbench report

With this module, the safety factors against yield, fissure, and fatigue fracture of all notches of a shaft can be determined as part of a system calculation. Individual notches can also be calculated by specifying the respective notch geometry and the nominal stresses.

[List of sources \(p. 70\)](#)

Shaft Load Capacity - FKM [WL_100.5]

Modeler	Extended	Advanced
	✓	✓

With this module, the FVA-Workbench can perform the calculated, static, and fatigue strength verifications for shafts. The fatigue strength verification includes analysis of the fatigue strength and fatigue limit.

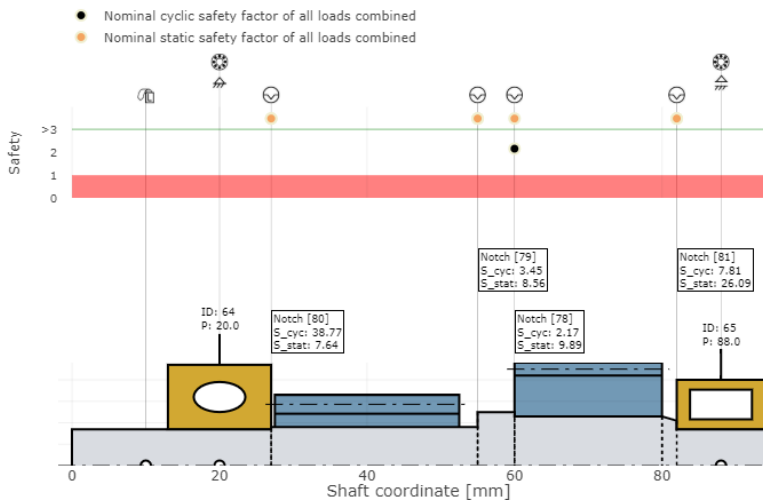

Representation of the cyclical and static safety values for each notch

The fatigue strength verification is performed for each notch. The loads on the notch are determined from the system calculation. These loads are then used to calculate the nominal stresses, which are automatically used for the verification.

The static verification is performed using the specified power flow data for the selected gear. If a load spectrum is specified, the loads for every load case are accumulated and the cyclical safety is calculated.

Press Fit Load Capacity - FVA 424 [WL_100.3]

Modeler	Extended	Advanced
	✓	✓

Interference fits are used to connect shafts and hubs using friction, where the torque is transmitted across the entire friction surface. Interference fits may develop a notch effect as a result of changes to the stiffness profile of the shaft. For this reason, it is essential to be able to reliably design and analyze these connections in detail. Calculations according to DIN 7190 and Kollmann can be performed with this module, which is based on the results of FVA Research Project FVA 424 [1].

The following influences are considered:

- Purely elastic and elastic-plastic stress on shaft and hub
- Different shaft and hub material characteristics
- The influence of centrifugal force for purely elastic designs
- The influence of temperature for purely elastic designs
- Stepped outer hub diameter
- Joining temperatures for heating the hub and/or cooling the shaft
- Joint fits can be calculated according to DIN 286

Stress curve (maximum oversize U_g)

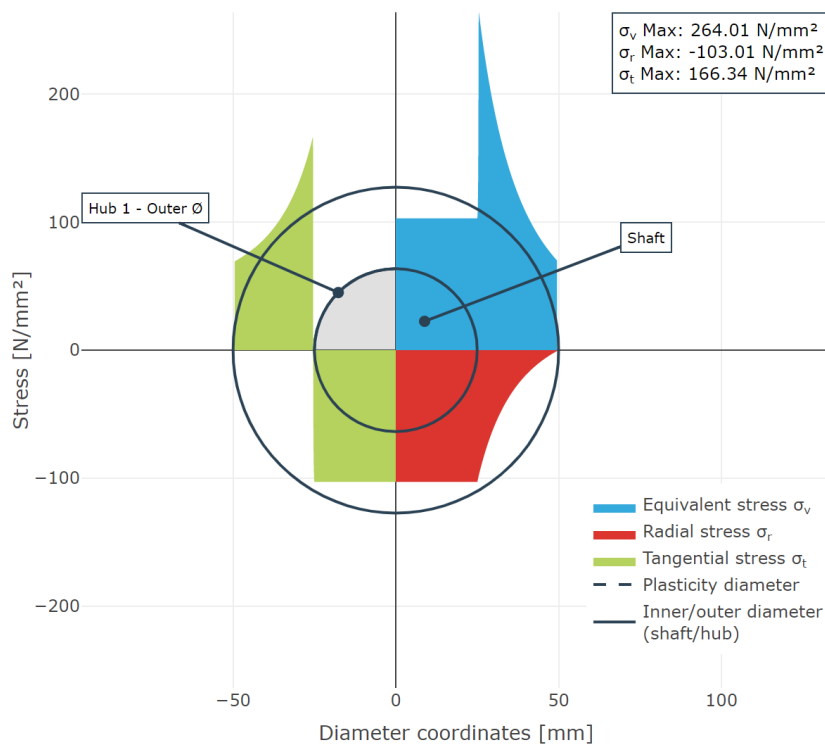

Visualization of the stresses of individual components in cross-section

[List of sources \(p. 70\)](#)

Feather Key Load Capacity - FVA 217 [WL_100.2]

Modeler	Extended	Advanced
	✓	✓

Feather keys are commonly used machine elements for creating positive locking shaft-hub connections. The torque is transmitted between the shaft and hub via a feather key. Since the feather key must be installed into the shaft and hub, it weakens them and creates a notch effect that cannot be neglected. For this reason, it is essential to be able to reliably design and analyze these connections in detail.

The calculation is based on methods from FVA Research Project 217 V [1], which were developed at the [Technische Universität Chemnitz](#). The calculation corresponds to the current state of research and has been extensively validated.

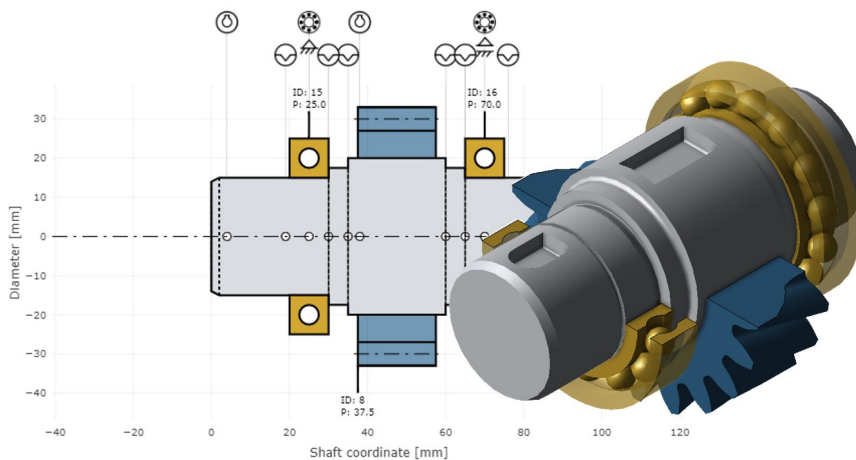

Representation of a shaft with multiple feather keys and notches in the 3D Model, and as a schematic sketch in a report

The feather key geometry can be designed according to DIN 6885 or user-defined, with tolerance classes and joining fits according to DIN 282. The load capacity analysis is performed according to DIN 6892 Methods B and C.

The calculation can be performed for an individual feather key or as part of a system calculation.

The results of the load capacity analysis are the safeties against yield, fatigue, and fissure. The fatigue notch factors can be output according to the DIN 743 "state of technology" or according to the "state of research." Overlapping notches can also be considered.

[List of sources \(p. 70\)](#)

Spline Gear Geometry and Load Capacity [ST_100.4]

Modeler	Extended	Advanced
✓	✓	✓

Splines with involute flanks are the most commonly used shaft-hub connections for the transmission of high amounts of torque as well as for centering shafts and hubs relative to each other.

The demand for higher torque and therefore higher power transmission has increased in recent years. Additionally, changing operating conditions are more common, which increases the stress on the spline and can lead to breakage.

The geometry of the spline is based on DIN 5480: Part 1 - 2006. The load capacity is calculated according to DIN 5466: Part 1 - 2000, with extensions from FVA Research Project 591 [1]. The permissible pressure and the safety factor of the spline according to Niemann/Winter/Höhn Machine Elements Volume 1 are also included in the strength calculation.

	Sym	[mm]		Sym	[mm]
Tip diameter [9]	d _a	67.6	Pitch diameter [8]	d	64
Root diameter [9]	d _f	58.983	Reference diameter [8]	d _B	68.4
Tip diameter [10]	d _a	-60.4	Tip clearance [9]	c	0.8
Root diameter [10]	d _f	-69.2	Tip clearance [10]	c	0.708

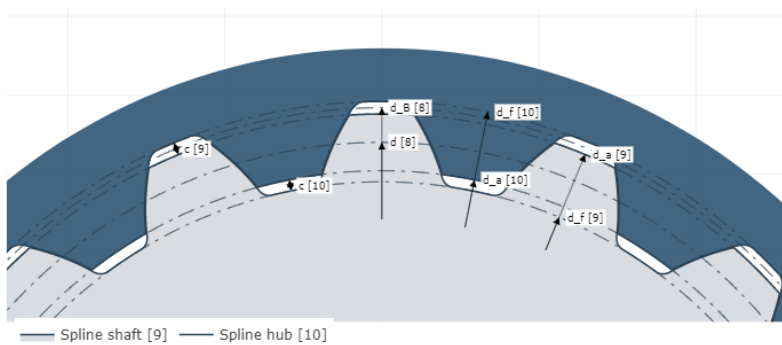

Gear mesh of a spline from an FVA-Workbench report

[List of sources \(p. 70\)](#)

Multiple Interference Fit Load Capacity - FVA 424 [WL_100.4]

Modeler	Extended	Advanced
	✓	✓

Multiple interference fits are used in many branches of the mechanical engineering and automotive industries. The product range extends from safety clutches to conveyor drives and detachable connecting elements for torque transmission.

This module is based on the results of FVA Research Project 424 [1]. The following influences are considered:

- Design of interference fits with more than two radial connection partners
- Consideration of purely elastic and elastic-plastic stress based on the von Mises maximum distortion energy theory (GEH)
- Consideration of material hardening under plastic stress
- Consideration of different component material characteristics
- Consideration of setting losses due to surface roughness
- Load capacity calculation with specification of joint pressure, interference, or fits
- Fit calculation according to DIN ISO 286
- Calculation of joining temperatures, depending on the specified joining clearance

Stress curve (maximum oversize Ug)

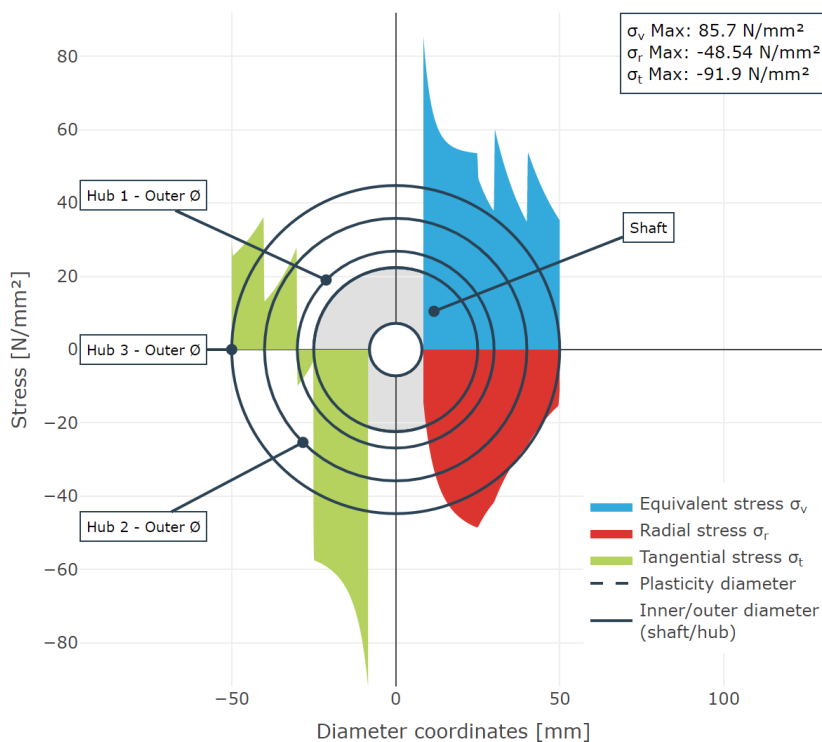

Visualization of the stresses of individual components in cross-section

[List of sources \(p. 70\)](#)

Load Spectrum Calculations [SYS_100.4]

Modeler	Extended	Advanced
	○	○

Most applications run at more than one operating point. Designing these applications for fatigue strength at nominal load often leads to very high material usage and weight.

This module can be used to design components for the planned operating time instead. The results of the load-time measurement series can be classified and specified in conjunction with the "Lifetime Estimation" module. Alternatively, synthetic load spectra can be created.

As part of the system calculation, load spectra can be specified as percentage changes of load and torque. The load spectra affect all drives and influence the load distribution in mesh, the load on the rolling bearings, and the load on the shafts.

The calculation can take a long time, especially with very large load spectra. To reduce the calculation time, the influence from the overall system can be interpolated section-by-section. To do this, a number of interpolation points are specified, and then a system calculation is performed for these interpolation points. For all other load levels, the loads are interpolated and used to determine the corresponding service life.

Cylindrical gear load spectrum calculations

For cylindrical gears, load spectra can be considered according to ISO 6336-6 (2019). The Wöhler curves can either be calculated according to the standard or specified from measurements. By integrating the calculation into the overall system, effects such as different face load factors or load distributions for planetary stages can be included in the analysis.

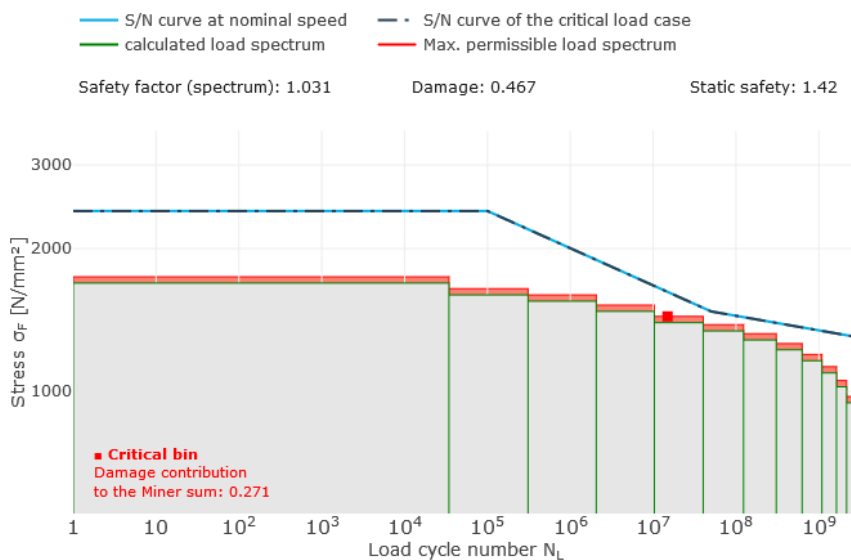

ISO 6336 Part 6 pressure spectrum and Wöhler curve for the tooth flank

Bevel gear load spectrum calculations

Bevel gears can be calculated in load spectra according to DIN 3991, ISO 10300 (2014), AGMA-C10, FVA 411, or using local damage accumulation. The underlying Wöhler curves are determined according to the standard. For the locally solved damage accumulation, damage occurring on the flank is accumulated and can be displayed as contour plots.

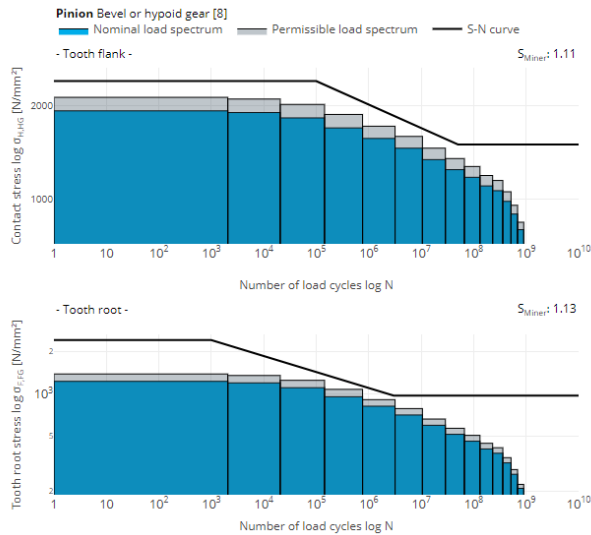

ISO 10300 tooth root and tooth flank Wöhler curves

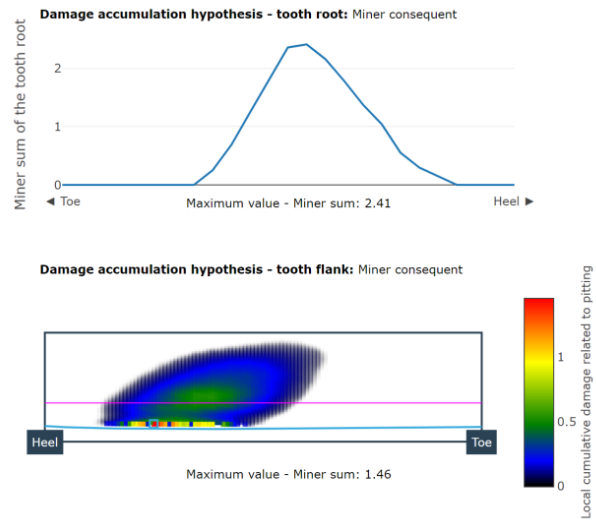

Tooth root and tooth flank damage accumulation

Rolling bearing load spectrum calculations

Load spectra are considered in the calculation of the service life of rolling bearings, and can be calculated for the service life according to DIN ISO 281, DIN ISO 281 Supplement 1, and DIN 26281, as well as according to manufacturer catalog calculations. Changes to the load situation of the tooth mesh are considered.

Shaft load spectrum calculations

Construction elements on the shaft often act as notches. For this reason, it is useful to also verify the load capacity in the load spectrum for critical applications. This verification is performed using the FKM Guideline based on the locally occurring nominal stresses.

Eigenvalue Analysis - FVA 565 [SYS_200.5]

Modeler	Extended	Advanced
	○	○

The eigenvalue calculation can be used to identify critical operating conditions in the gearbox early in the design phase. Eigenvalues are also calculated from the masses and the linearized stiffnesses at the operating point in the overall system and compared with the occurring excitation frequencies. As a result, the user is provided with a Campbell diagram for each gear stage and an animation of the eigenmodes in the 3D Model.

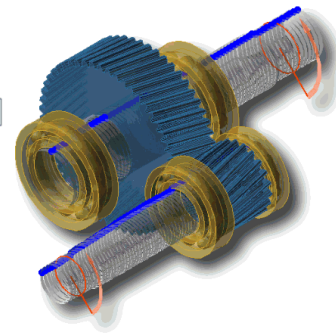
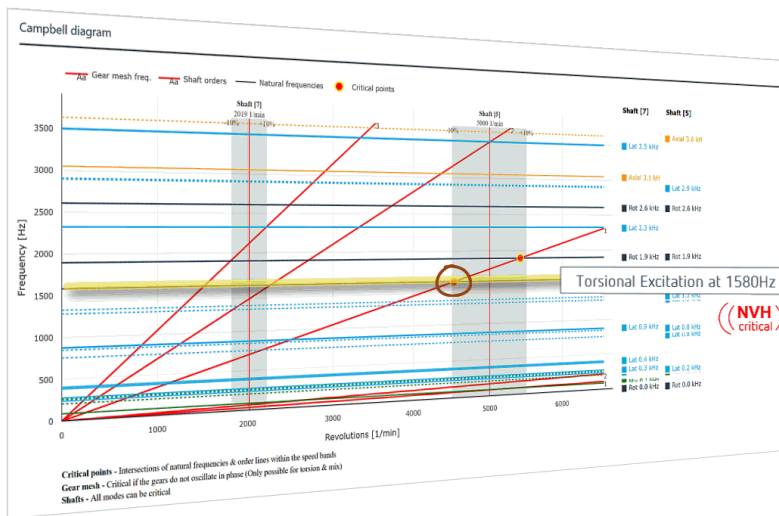

Representation of a critical, lateral eigenmode in the Campbell diagram and in the 3D View

Various types of gears can be considered in the eigenvalue calculation, such as cylindrical and bevel gears as well as planetary gears. For cylindrical gears, the dynamic gear stiffness can be determined automatically, or the gear stiffness can be specified if measurement results are available.

The result of the calculation is the natural frequencies and eigenmodes of the entire gearbox. The energy content of the different modes is analyzed in a post-processing step. The modes of vibration are divided into four categories: rotational, lateral, axial, or mixed.

The Campbell diagram is used to evaluate the critical operating points. The diagram consists of the speed on the x-axis and the frequency on the y-axis, and the shaft speeds are shown as vertical lines. The gear mesh frequencies and the shaft arrangements complete the diagram. If the rotational order and a natural frequency intersect within a speed range specified by the user, it represents a potential critical operating point. An additional check is performed for gears to determine whether torsional vibration occurs in the natural form. Only gears that do not vibrate in phase require closer examination.

The calculation is based on the loads in the transmission system, and is optional in the Extended and Advanced Editions. The eigenvalue calculation is based on the methods from FVA 565 [1].

[List of sources \(p. 70\)](#)

Lubrication Network Calculations - FVA 804 [LUB 200.1]

Modeler	Extended	Advanced
○	○	○

The internal lubricant distribution is critical for a reliable and efficient gearbox with a long service life. The lubrication and cooling system must be precisely designed to ensure that the desired amount of lubricant is supplied at each point of a mechanical gearbox. In FVA Project 804, a library was developed for simulation of gearbox lubrication and cooling networks with extended operating ranges using current lubricants. The characteristic diagrams of the flow resistance were created using CFD simulations and then cross-validated on the test bench. [1]

This module can be used to create and simulate lubricant networks with a simple drag & drop interface.

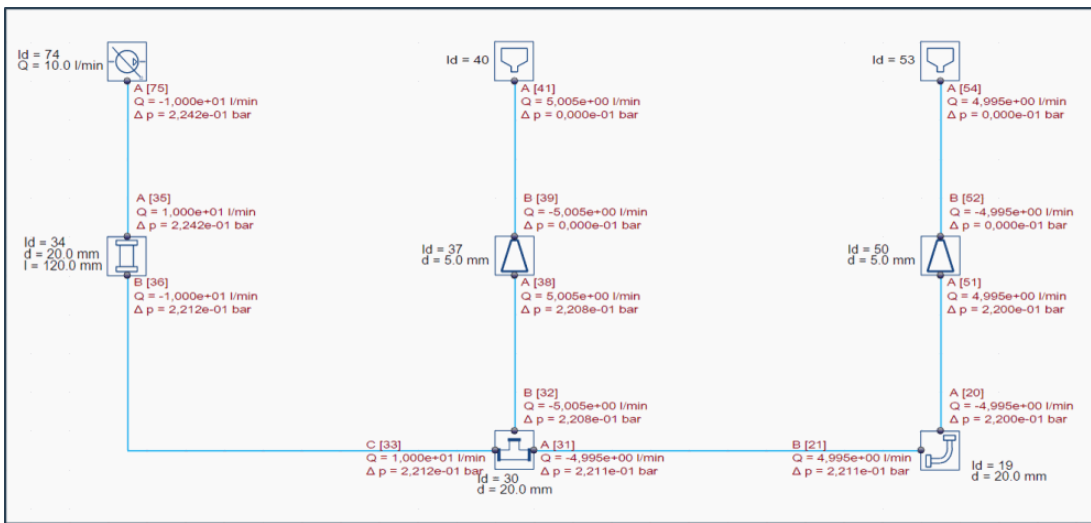

Representation of a lubricant network in the FVA-Workbench

[List of sources \(p. 70\)](#)

Coupling FEM Structures with the Analytical Calculation Model

When analyzing complex transmission systems, the boundary conditions must be modeled as closely as possible. By coupling FEM structures with the analytical calculation model, the influence of the gearbox casing, the planet carrier, and complex shaft geometries on the overall system can be considered.

This makes targeted design (for example, of gear modifications) possible, taking the deformation behavior of complex shaped components into consideration.

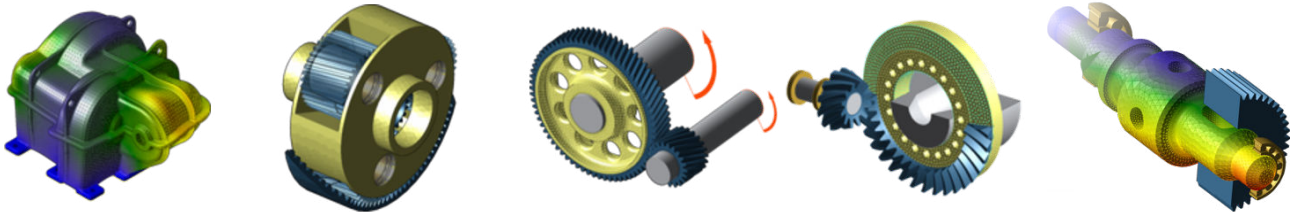

Gearbox casings, planet carriers, and wheel bodies for cylindrical and bevel gears as well as shafts can be considered as FE components.

Steps for integrating a CAD body as an FE structure

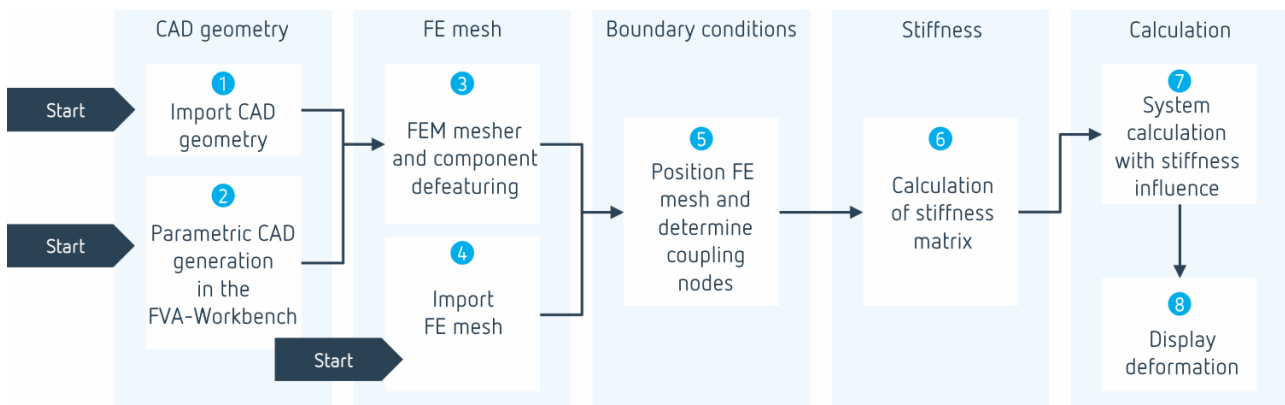

In the FVA-Workbench, the coupling of FE structures with the analytical model and the subsequent calculation is done in several steps via an interactive assistant.

An existing CAD file can be imported in the first step (1). Planet carriers and shafts can also be parametrically modeled directly in the FVA-Workbench (2). This makes it possible to consider the stiffness in an early design stage at a high level of detail with minimal effort.

In the second step, the CAD geometry can automatically be meshed. Parameters such as the mesh size, element type, and component defeaturing can be varied (3).

Alternatively, an FE mesh can be imported directly from a third-party application (4).

In the next step, the FEM component is positioned so that the bearing seats and bores are precisely aligned with the FVA-Workbench analytical model. For wheel bodies, the CAD geometry is automatically cut to enable correct connection to the gear. The coupling nodes between the mesh and the analytical model as well as the fixing nodes for casings are also determined. (5)

A reduced stiffness matrix is then created (6), which considers the stiffness of the FEM component in the system calculation. This matrix only needs to be determined once; recalculation is necessary only if the material data or coupling points change.

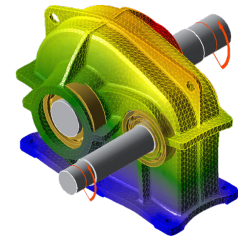
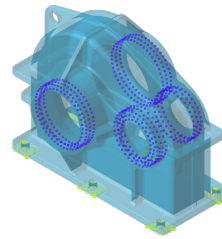
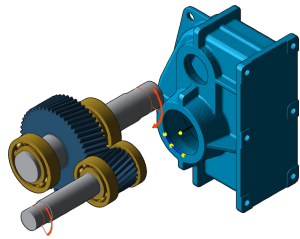
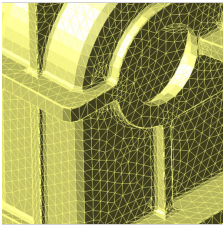

Meshing -> Positioning -> Define boundary conditions -> Calculate deformation

Module

No. in figure	Module	Applicable for
1	See table of importable CAD formats	Casings, wheel bodies, planet carriers, shafts
2	Always included	Planet carriers, shafts
3	FEM Mesher (Including STEP Import) [FEM_200.1]	Casings, wheel bodies, planet carriers, shafts
4	Abaqus (*.inp) & Ansys (*.dat) FE Mesh Import [SSFEMR_200.1]	Casings, planet carriers
5	Always included	Casings, wheel bodies, planet carriers, shafts
6	Casing FEM Connections - FVA 711 [SSFEM_200.2] Planet Carrier FEM Connections - FVA 774 [SSFEM_200.3] Shaft FEM Connections [SSFEM_200.4]	Casings, planet carriers, shafts
7	Always included	Casings, planet carriers, shafts
8	FEM Component Deformation [FEM_300.1]	Casings, planet carriers, shafts

Consideration of wheel bodies

The FEM wheel bodies are directly included in the local calculation methods for cylindrical and bevel gears. The design of the wheel body can have a strong influence on the position of the contact pattern and the pressure distribution.

Modules for Importing CAD Files and FE Meshes

Importable CAD formats	Importable FE mesh formats
STEP (included)	Z88 (included)
CATIA V5 Model Import (*.CATPart) [SSCADR_200.1]	Abaqus (*.inp) & Ansys (*.dat) FE Mesh Import [SSFEMR_200.1]
Pro/E Model Import (*.prt) [SSCADR_200.2]	
Solid Edge Model Import (*.par) [SSCADR_200.3]	
SolidWorks Model Import (*.sldprt) [SSCADR_200.4]	
Inventor Model Import (*.ipt) [SSCADR_200.5]	
SIEMENS NX Model Import (*.prt) [SSCADR_200.6]	

Casing FEM Connections - FVA 711 [SSFEM_200.2]

Modeler	Extended	Advanced
<input type="radio"/>	<input type="radio"/>	<input type="radio"/>

The FEM casing mesh is displayed in the 3D View together with the gearbox model. It can be positioned to the gear model in just a few clicks. The coupling nodes on the FEM model are automatically determined. The foundation nodes of the casing are also determined interactively.

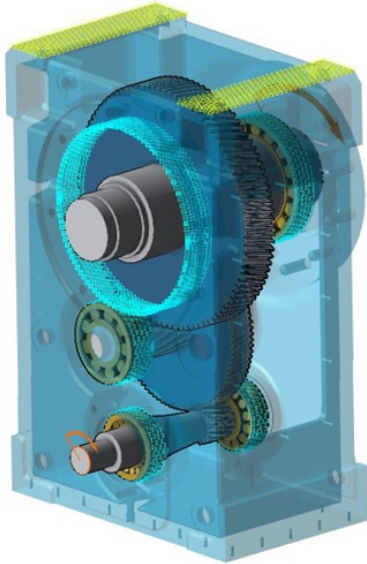

Color-coded FEM gearbox casing, bearing and foundation coupling nodes

This module makes it possible to calculate a reduced stiffness matrix for the casing model, which can be used to consider the influence of the elasticity of the casing on the stiffness in the overall system. [1]

[List of sources \(p. 70\)](#)

Planet Carrier FEM Connections - FVA 774 [SSFEM_200.3]

Modeler	Extended	Advanced
○	○	○

This module makes it possible to calculate a reduced stiffness matrix for the planet carrier, which can be used to consider the influence of the elasticity of the planet carrier on the stiffness in the overall system.

Background

In comparison to the purely elastic description of the planet carrier, three critical effects are taken into consideration:

1. Warping of the side plate

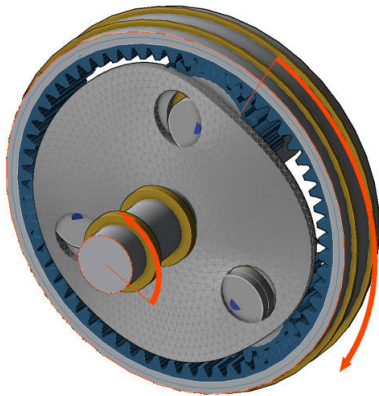

Tilting of pressed-in bolts due to warping

2. Influence of the strut geometry

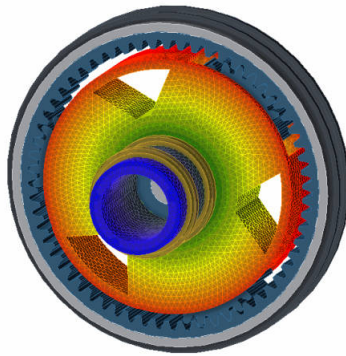

Realistic depiction of the influence of the strut on the stiffness behavior of the planet carrier

3. Twisting of the side plate

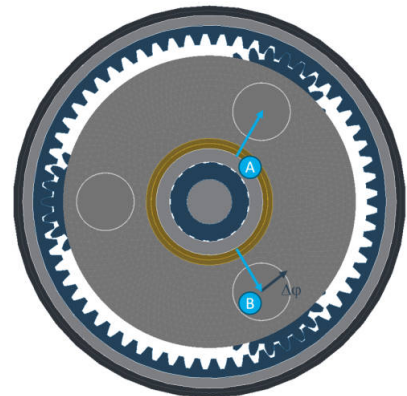

A - Analytical description

B - FEM considers an additional twist in the plane of the side plate ($\Delta\varphi$)

The planet carrier can be imported as CAD geometry or as an FEM mesh, or it can be modeled parametrically. This enables realistic representation of the planet carrier early in the design phase. Parametrically generated planet carriers can be meshed with the FEM Mesher (Including STEP Import) [FEM_200.1] module to achieve a continuous and efficient workflow.

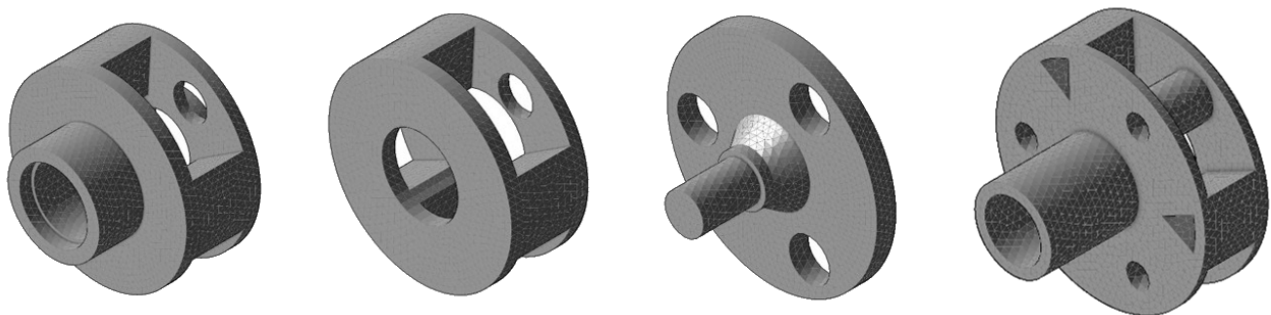

Various parametrically generated planet carriers

[List of sources \(p. 70\)](#)

Shaft FEM Connections [SSFEM_200.4]

Modeler	Extended	Advanced
	○	○

This module makes it possible to calculate a reduced stiffness matrix for shafts, which can be used to consider the influence of the stiffness of complex-shaped shafts in the overall system. The shaft can be imported as CAD geometry and meshed using the FEM Mesher (Including STEP Import) [FEM_200.1] module. The shaft is cut to the size of the gear to ensure correct connection to the analytical model. As an alternative to the CAD import, analytically modeled shafts can also be meshed.

Background

The purely analytical description of shafts is based on the Timoshenko approach. The bending deformation according to the Euler/Bernoulli method is combined with consideration of the shear deformation. The following restrictions apply when using the Timoshenko approach:

- The cross-sectional surface of the component is not warped
- Forces and moments are applied punctiform to the central axis
- The force flow in stepped shafts is not correctly considered

For most common shaft geometries, these limitations do not lead to practice-relevant deviations from the actual shaft deformation. However, the limitations of the Timoshenko beam theory can lead to noticeable shaft geometry deviations for more complex geometries. In this case, these shaft deformations can also be calculated using FEM.

Comparison of Timoshenko beam theory and FE calculations

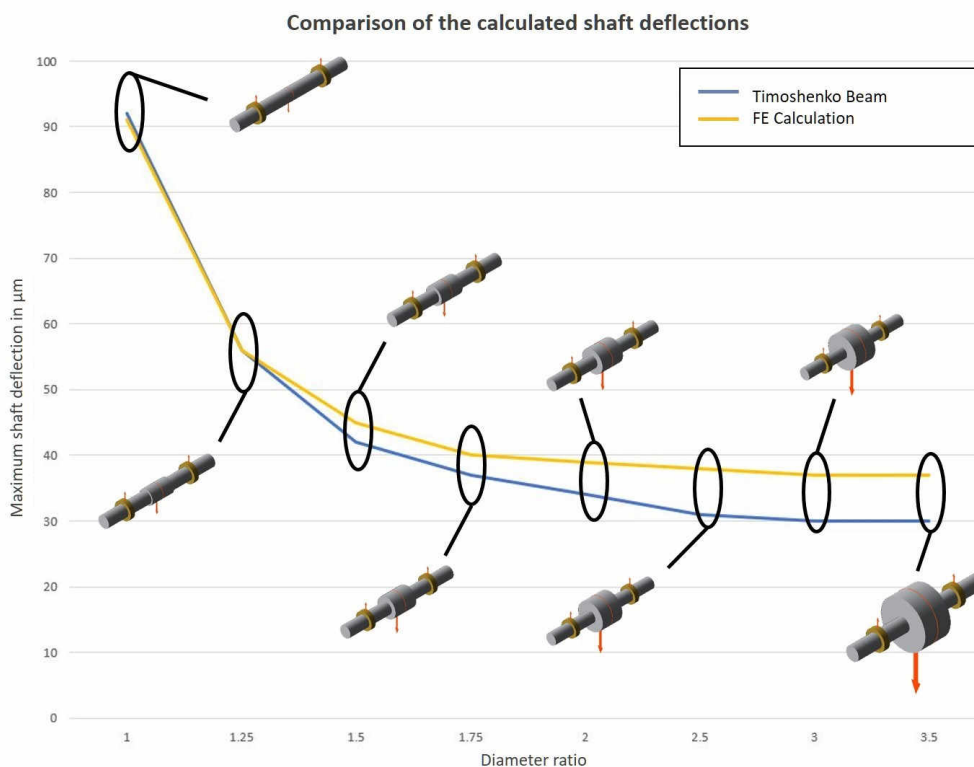

Maximum shaft deflection over the ratio of the outer diameter of the middle segment relative to the diameter of the adjacent shaft sections

FEM Mesher (Including STEP Import) [FEM_200.1]

Modeler	Extended	Advanced
○	○	○

The FEM mesher in the FVA-Workbench makes it possible to create FEM meshes from CAD geometry in just a few steps. The CAD geometry can be directly imported, or it can be internally parametrically generated for planet carriers and shafts. The simple, intuitive interface makes it easy to generate FEM meshes.

FEM mesher

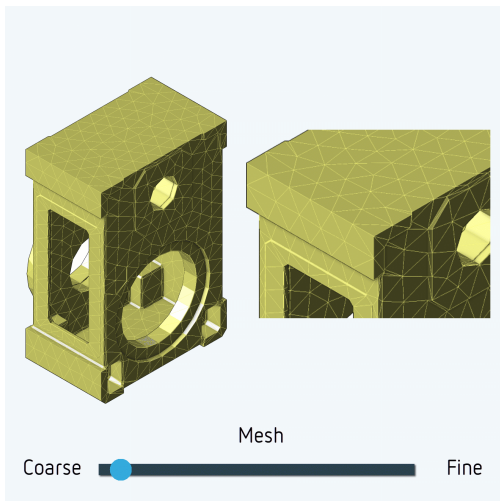

The mesh size can be adjusted in steps

Component defeaturing

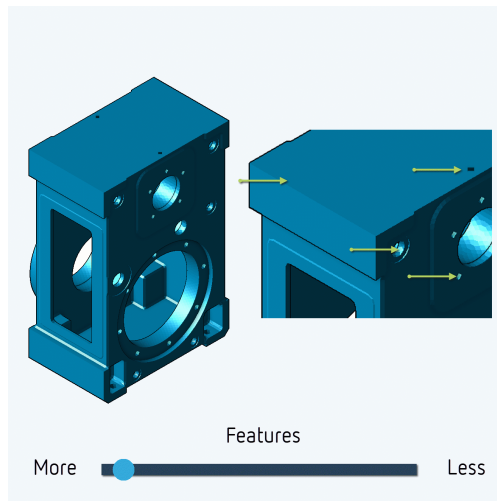

Non-relevant bores can be removed from the geometry step-by-step with component defeaturing

To achieve a high mesh quality with limited element distortion, it can be beneficial to remove small bores from the CAD geometry that are not relevant for the stiffness behavior. This is a fully automatic process; the size of the bores to be removed can be set using a slider. Time-intensive preparation of the CAD geometry for the stiffness calculation is not necessary.

The mesh qualification from FVA Research Project 484 V [1] is performed in order to be able to correctly consider the stiffness influence in the overall system. All unqualified elements are graphically represented in the FEM mesh, to give the user the opportunity to adapt the meshing parameters or correct the CAD geometry if necessary. For complex CAD geometries, information is output for every location in the geometry where meshing difficulties are encountered.

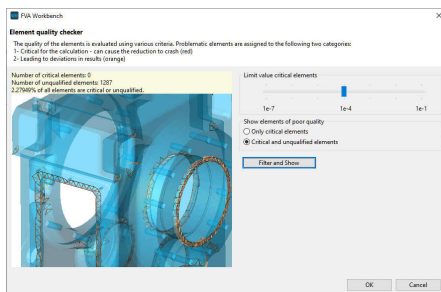

The meshing quality can be checked after meshing. Critical and non-critical elements are visually highlighted.

[List of sources \(p. 70\)](#)

FEM Component Deformation [FEM_300.1]

Modeler	Extended	Advanced
	<input type="radio"/>	<input type="radio"/>

Deformations of the FEM components can be calculated in order to verify the plausibility of the influence of the FEM components on the overall system. To do this, the forces on the coupling points from the entire system are applied to the reduction points of the FE component. This calculation is performed after the system calculation.

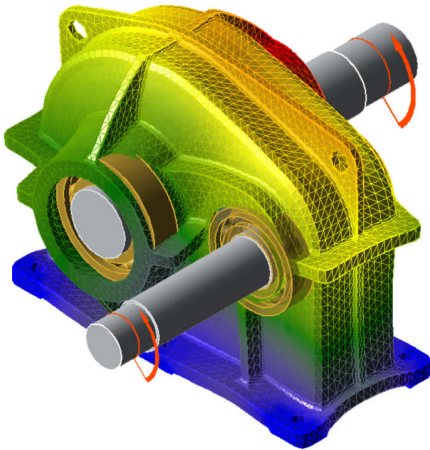

Exaggerated false-color representation of the deformation

The results of the deformation calculation can be output to the 3D visualization. The figure above shows an example of a false-color representation of a single-stage gearbox casing. The deformation of the gearbox elements and the FE bodies can be displayed simultaneously in the 3D visualization. The degree can be adjusted.

CAD Export

With the FVA-Workbench, the complete gearbox model or individual components can be exported in various CAD formats in high resolution.

The geometry of cylindrical and bevel gears corresponds exactly to the calculated geometry from the "Cylindrical Gear Geometry and Load Capacity - FVA 241 [ST_100.1]" and "Bevel Gear Local Load Capacity - FVA 223 [KS_200.3]" modules. For bevel gears, the micro-geometry (modification) used is always part of the CAD body, for cylindrical gears it is optional whether the micro-geometry is included in the CAD model.

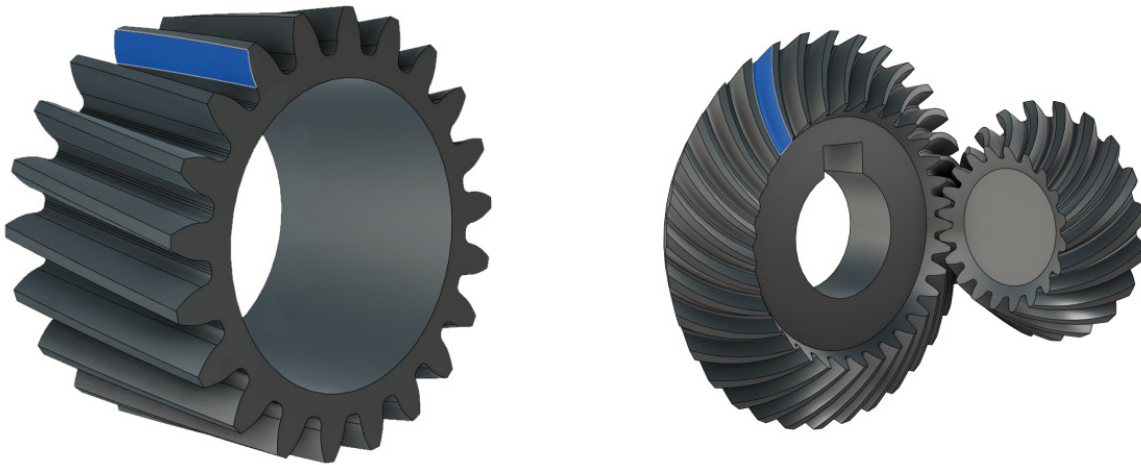

Representation of exported gears in a CAD program

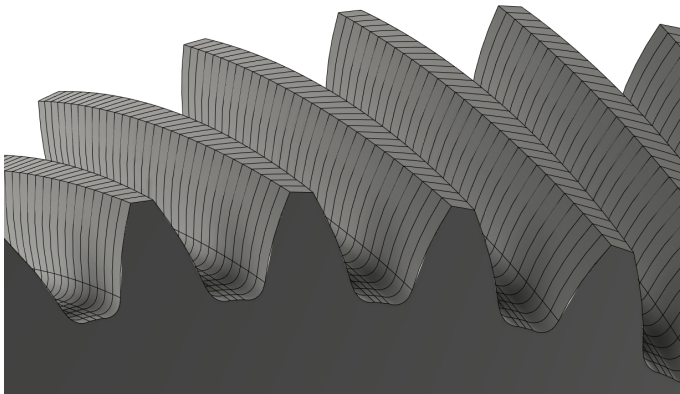

For cylindrical gears, the microgeometry (modification) used can optionally be exported in any resolution.

Exportable CAD Formats

The following formats can be licensed for export:

- CATIA V4 Export [SSCADW_200.1]
- CATIA V5 Export [SSCADW_200.2]
- IGES Export [SSCADW_200.3]
- STEP Export [SSCADW_200.4]
- VDA-FS Export [SSCADW_200.5]
- ACIS SAT Export [SSCADW_200.6]

Appendix

List of Sources

GDE Data Import [ST_200.7]

[1] FVA Vorhaben 839 "Industrie 4.0 – gerechte automatisierte Fertigungsmessdatenkopplung an die FVA-Workbench"

Lifetime Estimation

[1] FVA Vorhaben 485 I-VI "Geführte Lebensdauerberechnung für Komponenten der Antriebstechnik mit Vernetzung zur FVA-Software", final reports

[2] FVA Vorhaben 380 "Ermittlung von Bauteilwöhlerlinien mittels Künstlicher Neuronaler Netze", 2003, FVA-Heft 716

Efficiency and Temperature - FVA 69 [SYS_200.1]

[1] FVA Vorhaben 69 I – VII / Programmdokumentationen WTPLUS - final reports

[2] Ohlenorf, H.: Stirnradgetriebe - Zahnreibung, Verlustleistung und Erwärmung 1964 – dissertation

[3] FVA Vorhaben 372 "Verlustoptimierte Verzahnung", 2004, FVA-Heft 731

[4] Wech, L.: Untersuchungen zum Wirkungsgrad von Kegelrad- & Hypoidgetrieben / TU München, 1987 – dissertation

[5] Schlenk, L.: Untersuchungen zur Fresstragfähigkeit von Großzahnradern / TU München, 1995 – dissertation

[6] Doleschl, A.: Wirkungsgradberechnung von Zahnradgetrieben in Abhängigkeit vom Schmierstoff / TU München, 2002 – dissertation

[7] Mauz, W.: Hydraulische Verluste bei Tauch- und Einspritzschmierung von Zahnradgetrieben / Universität Stuttgart, 1985 – dissertation

[8] Walter, P.: Anwendungsgrenzen für die Tauchschmierung von Zahnradgetrieben, Plansch- und Quetschverluste bei Tauchschmierung / Universität Stuttgart, 1982 – dissertation

[9] FVA Vorhaben 44 "Ventilationsverluste", 1994, FVA-Heft 432

[10] Ariura, Y.: The Lubricant Churning Loss in Spur Gear Systems, JSME Vol. 16, pp. 881 -891, 1973 - publication

[11] Butsch, M.: Hydraulische Verluste schnelllaufender Stirnradgetriebe / Universität Stuttgart, 1989 – dissertation

[12] FVA Vorhaben 729 "Schneckengetriebewirkungsgrade", 2017, FVA-Heft 1126

[13] Linke, H.: Stirnradverzahnungen, 2. Edition, Hanser Verlag (2010)

[21] FVA Vorhaben 313 "Öltemperatur von Planetengetrieben", 2001, FVA-Heft 639

Gear Mesh Excitation - FVA 338 [ST_200.4]

[1] FVA Vorhaben 338 I "Anregungsverhalten bei Flankenkorrekturen", 2001, FVA-Heft 634

Cylindrical Gear 3D Flank Load Distribution - FVA 30 [ST_200.2]

[1] WEBER, C.; BANASCHEK, K.: Formänderung und Profilrücknahme bei gerad- und schrägverzahnten Rädern. Bd. 11. Schriftenreihe Antriebstechnik. Braunschweig: Vieweg-Verlag, 1955

[2] SCHMIDT, G.: Berechnung der Wälzpressung schrägverzahnter Stirnräder unter Berücksichtigung der Lastverteilung, TU München, dissertation, 1973

Cylindrical Gear 3D Flank Load Distribution - FVA 127 [ST_200.3]

[1] FVA Vorhaben 127 I – IX / FEM-Zahnkontaktanalyse STIRAK - final reports

[2] FVA Vorhaben 484 V "Einfluss elastischer Radkörperstrukturen auf die Tragfähigkeitsberechnung bei Stirnradverzahnungen", 2020, FVA-Heft 1366

Cylindrical Gear Local Tooth Root Stress - FVA 732 [ST_200.6]

[1] FVA Vorhaben 732 "Erstellung und Einbindung eines Programmmoduls zur schnellen numerischen Spannungsanalyse beliebiger Zahnquerschnitte in RIKOR", 2017, FVA-Heft 1246

Bevel Gear Load Capacity [KS_200.1]

[1] FVA Vorhaben 49 XIII: "Erweiterung des Kegelradnormprogramms KNplus", FVA-Heft 1342, Frankfurt, 2020

[2] FVA Vorhaben 411: "Berechnung der Grübchen- und Zahnfußtragfähigkeit von Kegelrädern", FVA-Heft 887, Frankfurt, 2009

[3] FVA Vorhaben 240 II: "Berechnung der Flankenbruchtragfähigkeit", FVA-Heft 690, Frankfurt, 2003

[4] FVA Vorhaben 516: "Bestimmung der Graufleckentragfähigkeit von Kegelrad- und Hypoidverzahnungen", FVA-Heft 1055, Frankfurt, 2011

[5] FVA Vorhaben 519: "Bestimmung der Fresstragfähigkeit von Kegelrad- und Hypoidverzahnungen", FVA-Heft 1071, Frankfurt 2011

[6] FVA Vorhaben 556 III: "Nachrechnung Flankenbruch Kegelräder", FVA-Heft 1100, Frankfurt, 2014

Bevel Gear Classification Societies - FVA 49 [KS_200.2]

[1] FVA Vorhaben 49 XIII: "Erweiterung des Kegelradnormprogramms KNplus", FVA-Heft 1342, Frankfurt, 2020.

Bevel Gear Local Load Capacity - FVA 223 [KS_200.3]

[1] FVA Vorhaben 777 III: "Durchgängigkeit lokale Berechnungsverfahren, Benutzeranleitung und Programmdokumentation - BECAL 6", final report, 2018

[2] FVA Vorhaben 223 XII: "Lokales Fressen und Schädigungsfortschritt der Zahnflanke durch Grauflecken sowie Grübchen", FVA-Heft 1277, Frankfurt, 2018.

[3] FVA Vorhaben 223 XIII: "Berechnung vereinfachter Maschineneinstellungen für BECAL auf Basis der ISO 23509 zum Anschluss an die FVA-Workbench ", FVA-Heft 1193, Frankfurt, 2016

[4] FVA Vorhaben 223 XV: "Berechnung der Tragbildabmessungen und -lagen an bogenverzahnten Kegelrädern", FVA-Heft 1343, Frankfurt, 2020

[5] FVA Vorhaben 223 XVI: "Methode zur Einbeziehung der Steifigkeit komplexer Radkörper in die Lastverteilungsberechnung und deren Umsetzung in BECAL", FVA-Heft 1372, Frankfurt, 2020

[6] FVA Vorhaben 411: "Berechnung der Grübchen- und Zahnfußtragfähigkeit von Kegelrädern", FVA-Heft 887, Frankfurt, 2009

[7] FVA Vorhaben 516: "Bestimmung der Graufleckentragfähigkeit von Kegelrad- und Hypoidverzahnungen", FVA-Heft 1055, Frankfurt, 2011

[8] FVA Vorhaben 519: "Bestimmung der Fresstragfähigkeit von Kegelrad- und Hypoidverzahnungen", FVA-Heft 1071, Frankfurt, 2011

Worm Gear Load Capacity - FVA 320 [SN_200.1]

[1] FVA Vorhaben 320 I – VII / Programmdokumentationen SNESYS - final reports

[2] FVA Vorhaben 320 VII "Anwendungsorientierte Kombination von Verschleiß und Grübchensimulation in SNETRA", 2018, FVA-Heft 1301

- [3] FVA Vorhaben 320 IV "FVA-Schneckenprogramm SNESYS", 2001, FVA-Heft 556
- [4] FVA Vorhaben 141 II "Fressen bei Schneckengetrieben" 1999, FVA-Heft 211
- [5] FVA Vorhaben 12 IV "Grübchentrugfähigkeit Schneckengetriebe", 1996, FVA-Heft 494
- [6] FVA Vorhaben 205 "Schneckenradbronzen - Tragfähigkeitssteigerung von Schneckengetrieben durch Optimierung der Schneckenradbronze", 1996, FVA-Heft 476
- [7] FVA Vorhaben 465 I "Schneckengetriebe - Lastkollektive", 2013, FVA-Heft 1057

Worm Gear Local Load Capacity - FVA 320 [SN_200.2]

- [1] FVA Vorhaben 320 VII "Anwendungsorientierte Kombination von Verschleiß und Grübchensimulation in SNETRA", 2018, FVA-Heft 1301
- [2] FVA Vorhaben 320 I – VII / Programmdokumentationen SNESYS - final reports
- [3] FVA Vorhaben 553 "Praxis Leitfaden FVA Schneckenprogramme ZSB/ZSP", 2007, FVA-Heft 840
- [4] FVA Vorhaben 460 "Schneckenradsätze (SNESYS II): Werkzeugdatenbasierte Auslegung von Schneckenradsätzen", 2007, FVA-Heft 845
- [5] FVA Vorhaben 260 "FVA Schneckengetriebe - Selbstbremsung", 1998, FVA-Heft 544
- [6] FVA Vorhaben 138 "Schneckenradselbsthemmung", 1992, FVA-Heft 368

Crossed Helical Gear Load Capacity - FVA 651 [SCH_200.1]

- [1] FVA Vorhaben 651 II "Erweiterungen SCHRAD 2", 2020, FVA-Heft 1367
- [2] FVA Vorhaben 651 I "Integration der Schraubradgetriebe in die FVA-Workbench", 2014, FVA-Heft 1084
- [3] FVA Vorhaben 26 "EDV-Programm zur Berechnung zylindrischer Schraubradgetriebe", 1976, FVA-Heft 37
- [4] Niemann, G.; Winter, H.: Maschinenelemente - Band 3: Schraubrad-, Kegelrad-, Schnecken-, Ketten-, Riemen-, Reibradgetriebe, Kupplungen, Bremsen, Freiläufe. Springer-Verlag, Berlin, Heidelberg, New York, Tokyo, 2. Auflage (1986)
- [5] Wassermann, J.: Einflussgrößen auf die Tragfähigkeit von Schraubradgetrieben der Werkstoffpaarung Stahl/ Kunststoff / Ruhr-Universität Bochum 2005 - dissertation
- [6] Wendt, T.: Tragfähigkeit von Schraubradgetrieben mit Schraubrädern aus Sintermetall / Ruhr-Universität Bochum, 2008 - dissertation
- [7] Hoechst AG: Technische Kunststoffe, Berechnen Gestalten Anwenden B.2.2 Schneckengetriebe mit Schneckenrädern aus Hostaform, 1992 - company publication
- [8] VDI 2736-3:2012-11: Thermoplastische Zahnräder Schraubradgetriebe Paarung Zylinderschnecke Schrägstirrad Tragfähigkeitsberechnung - Blatt 3 (2012).
- [9] Pech, M.: Tragfähigkeit und Zahnverformung von Schraubradgetrieben der Werkstoffpaarungen Stahl/Kunststoff / Ruhr-Universität Bochum, 2011 - dissertation

Rolling Bearing Calculations - FVA 668 & FVA 364 [WL_200.1]

- [1] FVA Vorhaben 668, "Erweiterte Leistungsfähigkeit von Welle-Lager-Berechnungen mit dem Modul WELLAG ", 2015, FVA-Heft 1150
- [2] FVA Vorhaben 364, "EDV-Unterprogramm zur Berechnung der Steifigkeit und der Lebensdauer von Wälzlagern", 2002, FVA-Heft 674

Thrust Bearing Simulations - FVA 668 [GL_200.2]

- [1] FVA Vorhaben 668 II "Durchgängige Berechnung gleitgelagerter WelleLager-Systeme", 2018, FVA-Heft 1282

Journal Bearing Simulations - FVA 577 [GL_200.1]

[1] FVA Vorhaben 577 "Stationär und instationär hoch belastete Radialgleitlager für schnell laufende Rotoren bei Berücksichtigung der Lagerdeformationen", Abschlussbericht, FVA-Heft Nr. 996

FVA Vorhaben 677 "Einfluss der Ölzuführung auf die hydraulischen, energetischen und mechanischen Vorgänge in schnell laufenden und hoch belasteten Radialkippssegmentlagern"

Shaft Load Capacity - DIN 743 & FVA 700 [WL_100.1]

[1] DIN 743: Tragfähigkeitsberechnung von Wellen und Achsen / Beuth Verlag Berlin, 2012

[2] FVA Vorhaben 700 "Berechnung von Mehrfachkerben nach DIN 743 durch Einbindung von FEM-Ergebnissen", 2016, FVA-Heft 1182

[3] FVA Vorhaben 700 II "Softwareintegration + Validierung Mehrfachkerbe", 2018, FVA-Heft 1311

Press Fit Load Capacity - FVA 424 [WL_100.3]

[1] FVA Vorhaben 424 "Beanspruchungsgerechte Dimensionierung von Pressverbindungen", 2005, FVA-Heft 757

Feather Key Load Capacity - FVA 217 [WL_100.2]

[1] FVA Vorhaben 217 V "Erstellung des Passfeder-Berechnungsprogramms KeyFit sowie Integration in die FVA-Workbench", 2012, FVA-Heft 1041

Spline Gear Geometry and Load Capacity [ST_100.4]

[1] FVA Vorhaben 591 "FVA-Berechnungsrichtlinie für Zahnwellen-Verbindungen", 2015, FVA-Heft 1139

Multiple Interference Fit Load Capacity - FVA 424 [WL_100.4]

[1] FVA Vorhaben 424 III "Erweiterung des Berechnungsprogramms PressFit für elastisch und elastisch-plastisch beanspruchte Mehrfachpressverbände", 2015, FVA-Heft 1170

Eigenvalue Analysis - FVA 565 [SYS_200.5]

[1] FVA Vorhaben 565 "Untersuchung des Drehzahleinflusses auf das Geräusch- und Schwingungsverhalten von mehrstufigen Getrieben unter Berücksichtigung der Kopplung der Getriebestufen", 2012, FVA-Heft 1013

Lubrication Network Calculations - FVA 804 [LUB 200.1]

[1] FVA Vorhaben 804 "Berechnung der Schmierstoffverteilung in Getrieben"

Casing FEM Connections - FVA 711 [SSFEM_200.2]

[1] FVA Vorhaben 711 "Einbindung elastischer Gehäusestrukturen in die Getriebeauslegung mit RIKOR und Visualisierung des Getriebegesamtssystems in der FVA-Workbench", 2017, FVA-Heft 1250

FEM Mesher (Including STEP Import) [FEM_200.1]

[1] FVA Vorhaben 484 V "Einfluss elastischer Radkörperstrukturen auf die Tragfähigkeitsberechnung bei Stirnradverzahnungen", 2020, FVA-Heft 1366

Planet Carrier FEM Connections - FVA 774 [SSFEM_200.3]

[1] FVA Vorhaben 774 I – "Dachprojekt Themenkomplex Planetenradverformung", 2022